

TM

# sonaris

PERFORATED ACOUSTIC LAMINATED FINISHES



TECHNICAL DATA SHEET



# sonaris™

## Perforated acoustic laminated finishes

### Technical Data Sheet

Sonaris™ a revolutionary perforated glass mat laminate finish for ceilings. Sonaris™ is designed to provide a decorative acoustically transparent laminate finish to a broad range of ceiling materials such as polyester, mineral fibre, glass fibre board, rockwool, and plasterboard. Panels can be provided at NRC 0.1 to 1.00 and CAC from 15 to 45dB. With a dual layer structure, colours can be added for effect but white on white remains the most popular option as it gives a subtle textural finish to white ceilings. Sonaris™ is manufactured in NZ, is light weight, non combustible, low in embodied energy, low VOC, easily customized, economical and made in a range of perforation patterns. Custom perforation patterns are available to order.

#### Application

Sonaris™ is ideal for use as a decorative finish to acoustic ceiling panels in corporate offices, boardrooms, lobbies, retail and hospitality areas, education facilities and governmental buildings.

#### Composition

Made in NZ from a proprietary Sonatex™ glass mat composite board perforated in a range of designs and laminated onto a variety of acoustic base material.

#### Features & Benefits

- Provides an attractive perforated aesthetic to various acoustical base board ceiling panels.
- Acoustically transparent, can be tuned to provide high sound absorption up to NRC 1.00 and STC to 29dB.
- Available in a range of perforated designs.
- Custom sizes and special perforation designs available to order.
- Standard white on white finish plays on the subtle shifts in light and shadow to provide a unique aesthetic.
- Contrasting grey and black background enhances the perforated look.
- Custom RAL colours available to order.
- Standard 600 x 600 or 1200 x 600 mm lay in ceiling panel format suits most projects and is fast to install.
- Each panel has 8 x proprietary panel location tabs to align the perforations for a consistent aesthetic.
- Prefinished, light weight, dimensionally stable.
- Cut outs for M/E services available to order.
- Non combustible glass fibre composition.
- Lower installation costs compared to perforated MDF and Ply panels.

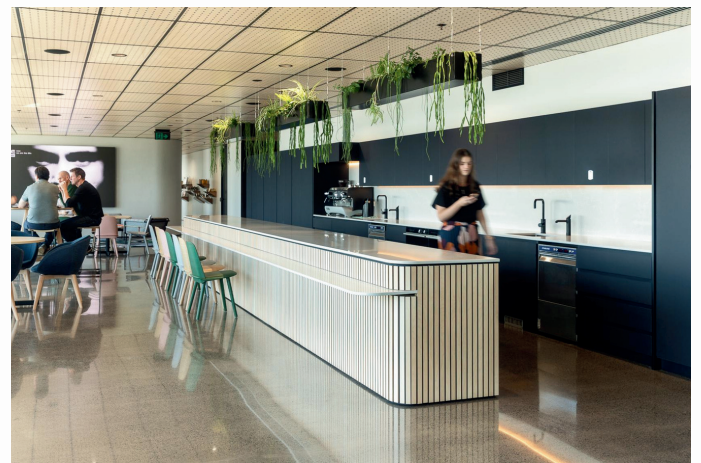
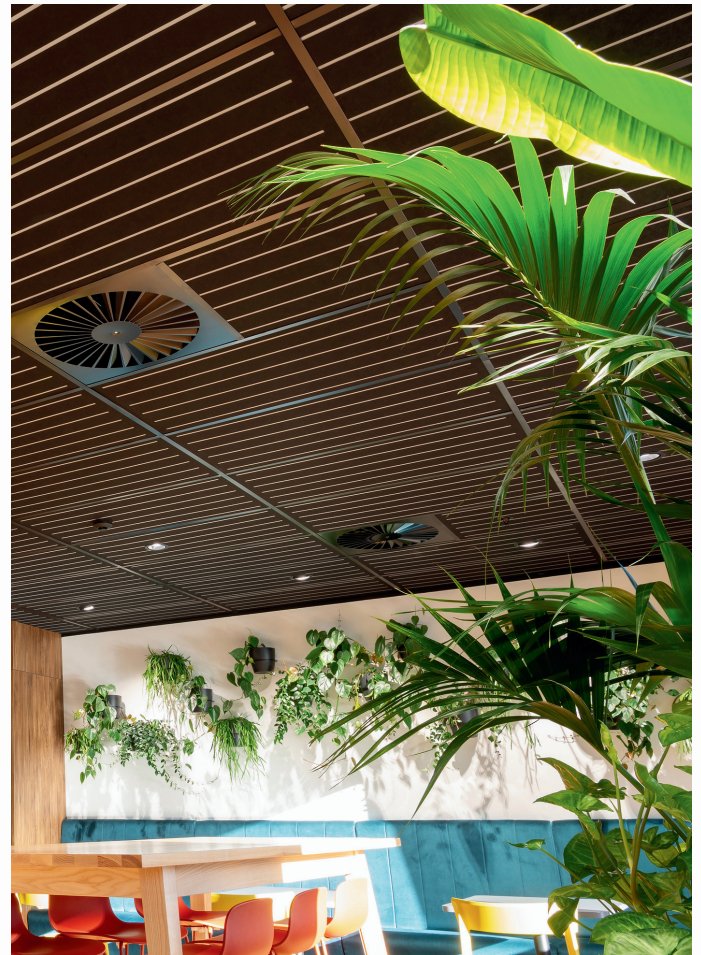



# Sonaris™

## Perforated Acoustic Laminated Ceiling Tile

### Perforations:

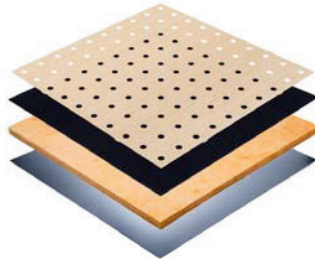

Sonaris P15-60

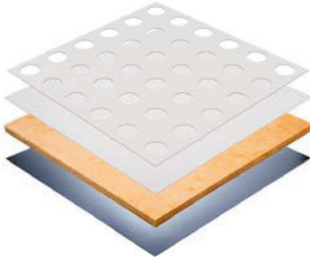

Sonaris P55-100

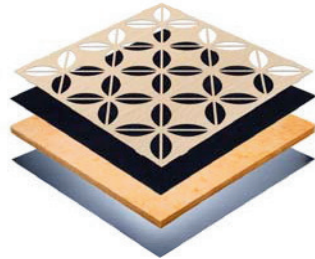

Sonaris FP100

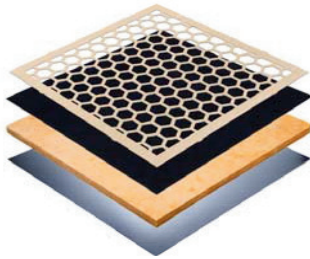

Sonaris 4040H

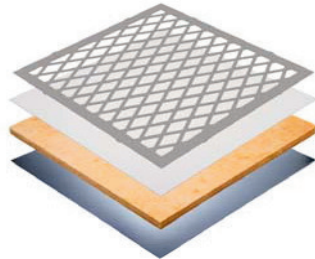

Sonaris 4071D

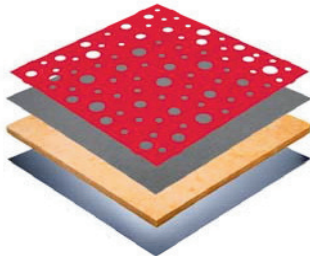

Sonaris 163040R



Sonaris S4-25

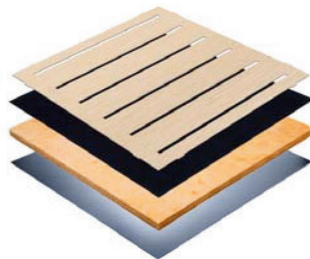

Sonaris S10-100

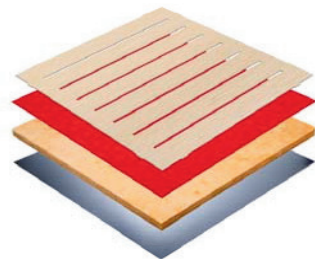

Sonaris S7-75

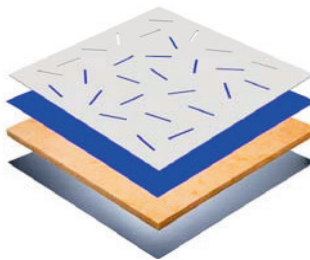

Sonaris RSlot

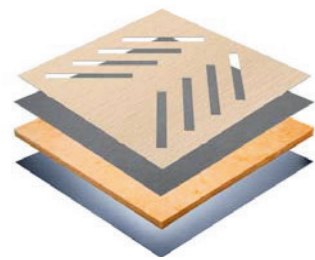

Sonaris 250/25HB

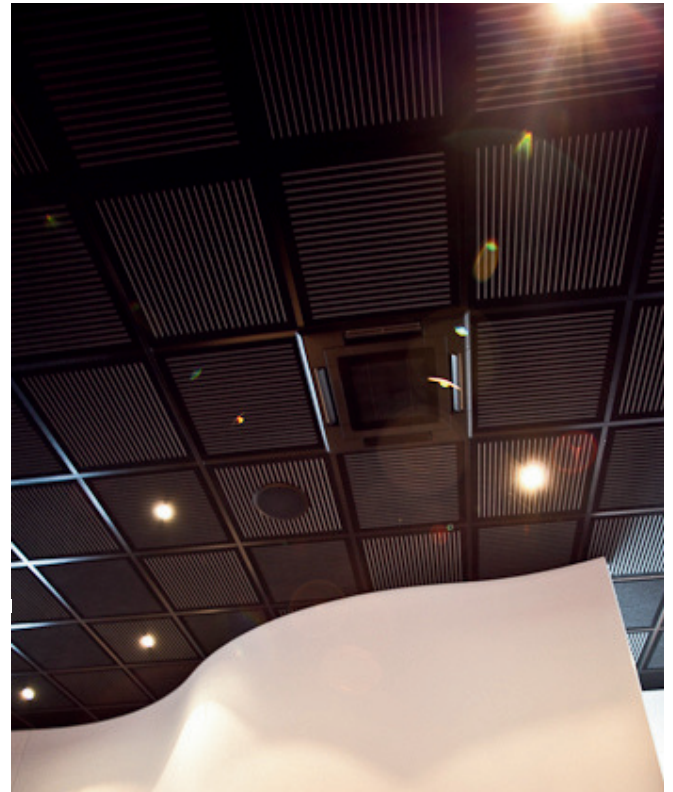

Ref. Sonaris-1711 Patent No. NZ2009208100

Patent No. AU570507

# Sonaris™ #P55-100

## Perforated acoustic ceiling panel laminate finish

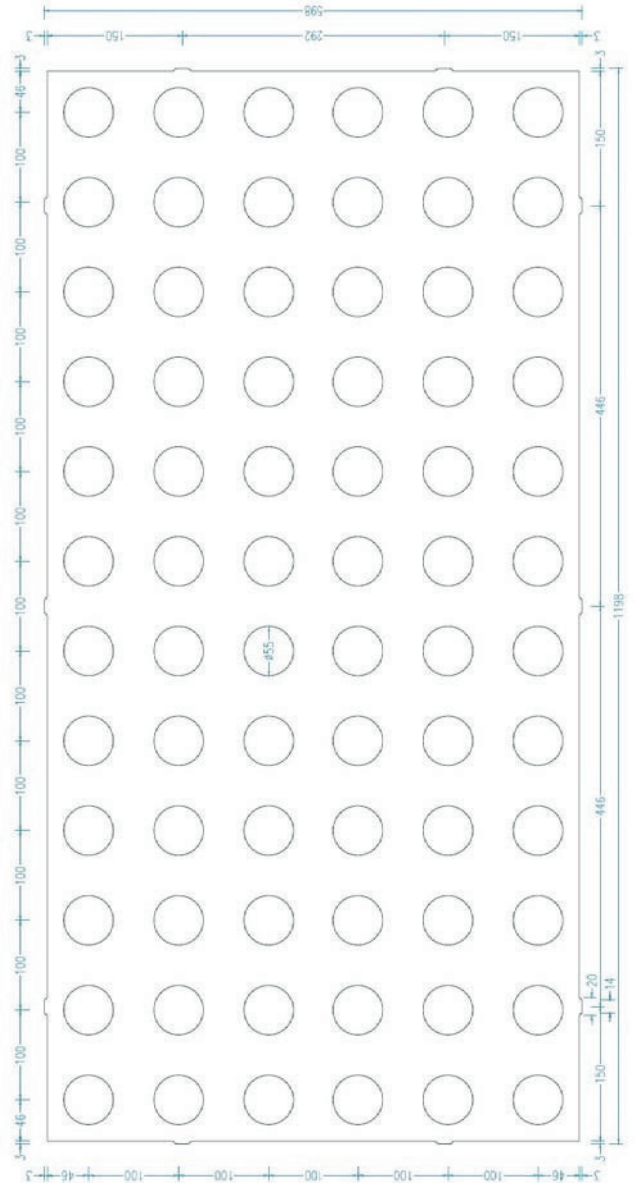
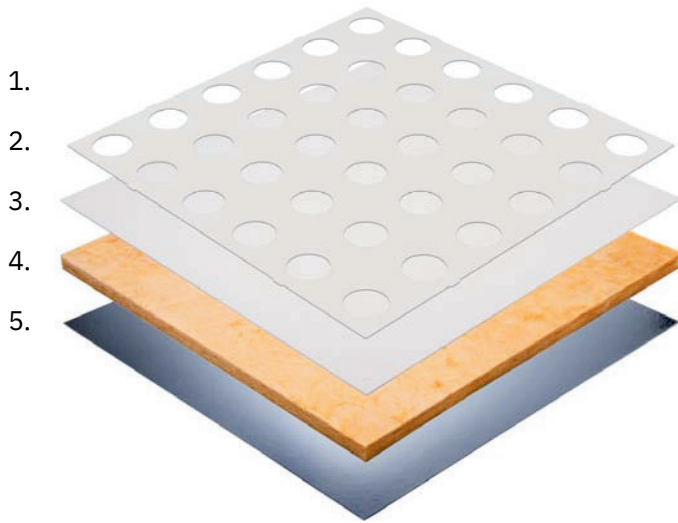
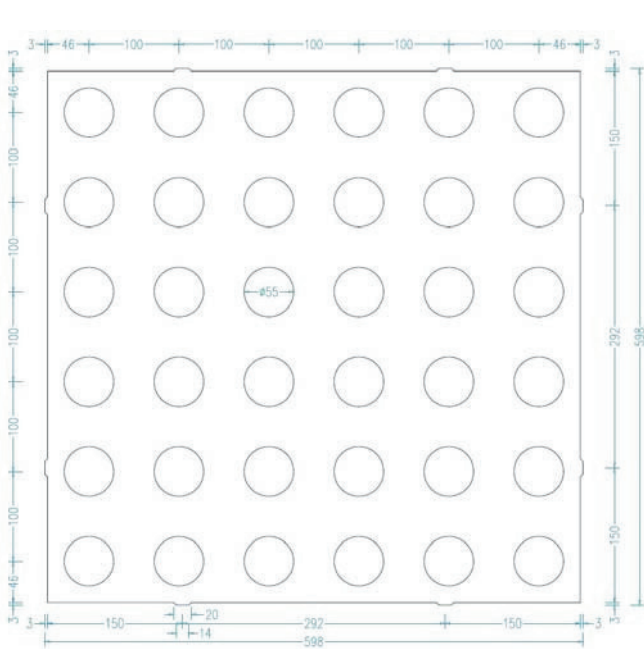

### Sizes: # P55-100

600 x 600 mm or 600 x 1200 mm  
55mm Ø perf @ 100mm centres.

### How to select your Sonaris™ laminate ceiling:

1. Select perforation panel size.
2. Select your surface colour/print (see Sonatex colour range datasheet).
3. Choose your base colour. (see Sonatex colour range datasheet).
4. Select your base panel type: Triton Range (Glass Fibre), Polyfon Range (Polyester).
5. Optional: Noise attenuation backer.

### Specification:

Acoustic ceiling panel shall be Asona (Triton) (Polyfon) size: (600 x 600mm), (600 x 1200mm), with Sonaris™ perforation pattern #P55- 100, surface colour: (white) (other), Base colour: (white) (other), with (optional) attenuation backer, as manufactured by Asona Ltd, +64 (9) 525 6575, info@asona.co.nz.

Ref. Sonaris #P55-100-1710

Patent No. NZ2009208100

Patent No. AU570507

ISO 9001:2015 Registered Firm No. NZ1014

© 2023 Copyright ASONA Ltd Asona, Sonatex and Sonaris are trade marks of Asona Ltd.  
All dimensions are nominal. We reserve the right to change specifications.  
Ref. Sonatex and Sonaris-24.10

Asona Ltd.  
Office and Factory  
6 Mahunga Drive, Māngere  
Bridge, Auckland 2022  
New Zealand

Contact  
T: +64(0)9 525 6575  
E: info@asona.co.nz  
W: www.asona.co.nz  
NZBN: 9429036035175

**asona**



# Sonaris™ #P15-60

## Perforated acoustic ceiling panel laminate finish

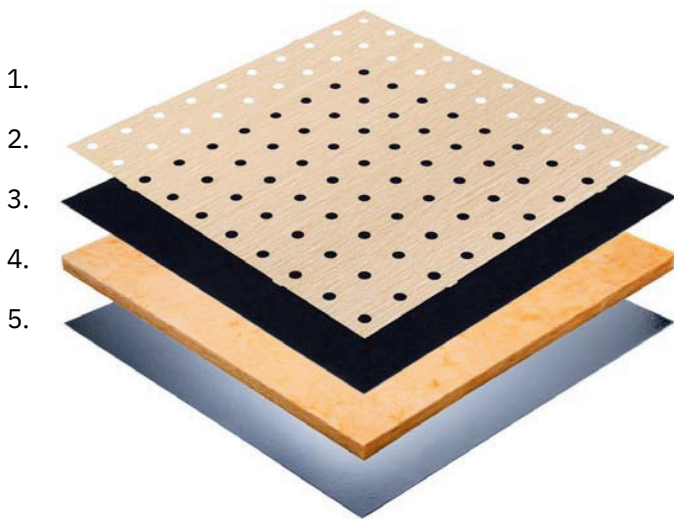
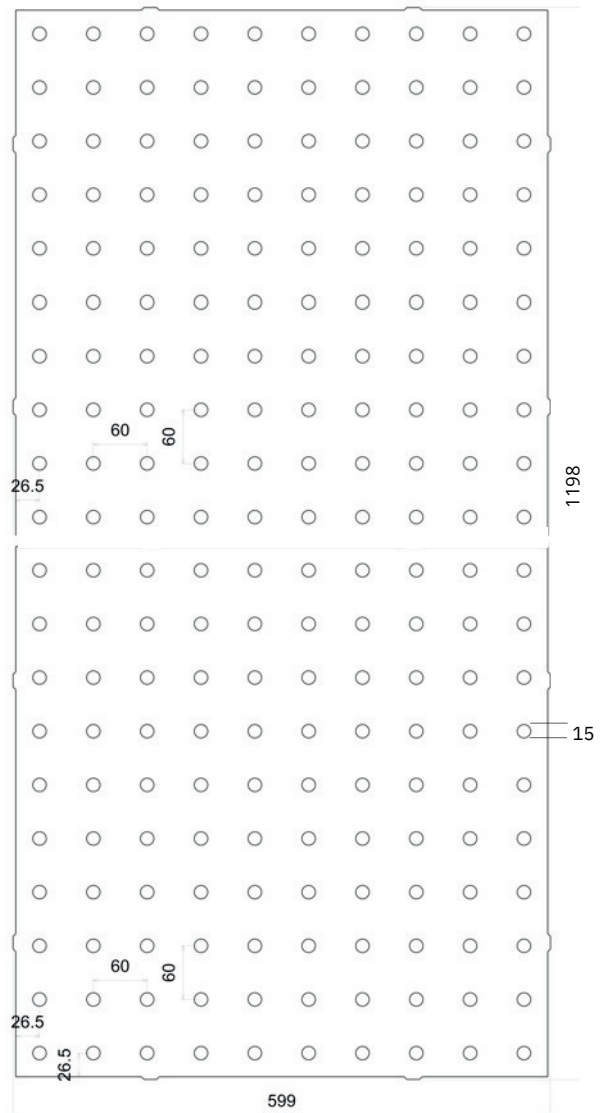
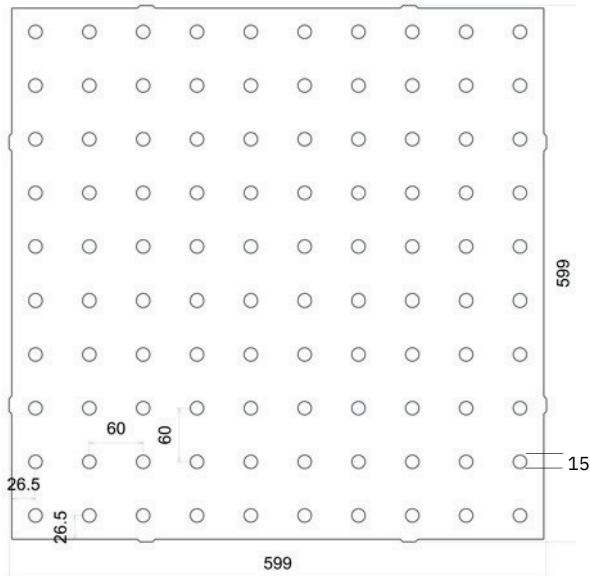

### Sizes: # P15-60

600 x 600 mm or 600 x 1200 mm  
15mm Ø perf @ 60mm centres.

### How to select your Sonaris™ laminate ceiling:

1. Select perforation panel size.
2. Select your surface colour/print (see Sonatex colour range datasheet).
3. Choose your base colour. (see Sonatex colour range datasheet).
4. Select your base panel type: Triton Range (Glass Fibre), Polyfon Range (Polyester).
5. Optional: Noise attenuation backer.

### Specification:

Acoustic ceiling panel shall be Asona (Triton) (Polyfon) size: (600 x 600mm), (600 x 1200mm), with Sonaris™ perforation pattern #P15- 60, surface colour: (white) (other), Base colour: (white) (other), with (optional) attenuation backer, as manufactured by Asona Ltd, +64 (9) 525 6575, [info@asona.co.nz](mailto:info@asona.co.nz).

Ref. Sonaris #P15-60-1801

Patent No. NZ2009208100

Patent No. AU570507

ISO 9001:2015 Registered Firm No. NZ1014

© 2023 Copyright ASONA Ltd Asona, Sonatex and Sonaris are trade marks of Asona Ltd.  
All dimensions are nominal. We reserve the right to change specifications.  
Ref. Sonatex and Sonaris-24.10

Asona Ltd.  
Office and Factory  
6 Mahunga Drive, Māngere  
Bridge, Auckland 2022  
New Zealand

Contact  
T: +64(0)9 525 6575  
E: [info@asona.co.nz](mailto:info@asona.co.nz)  
W: [www.asona.co.nz](http://www.asona.co.nz)  
NZBN: 9429036035175

**asona**

# Sonaris™ #FP100 Frangipani

## Perforated acoustic ceiling panel laminate finish

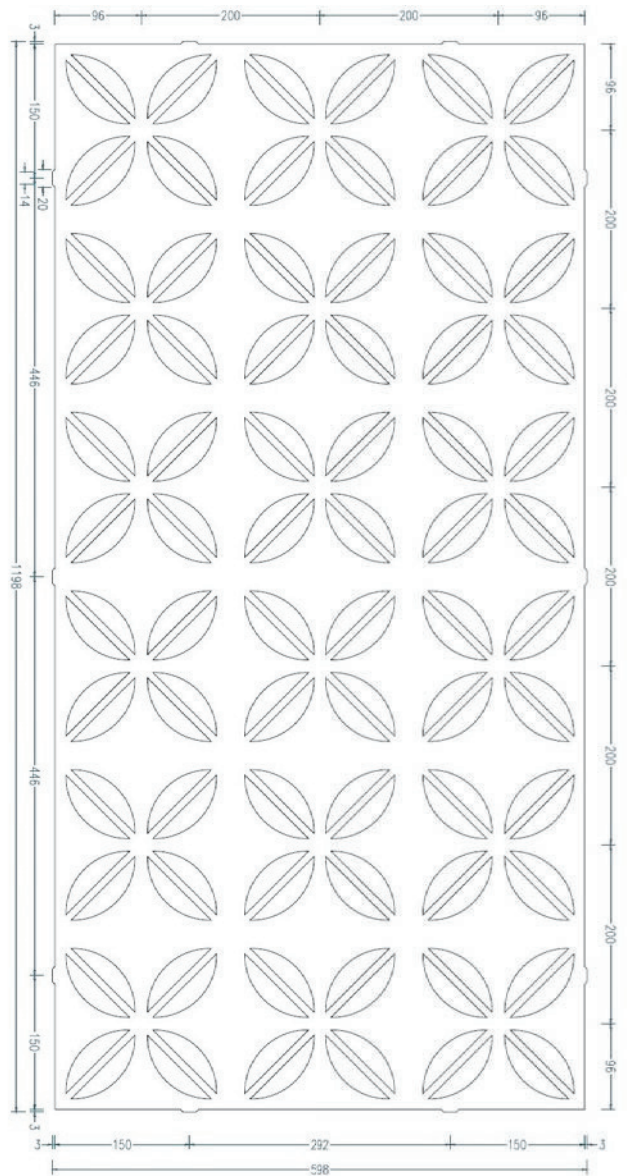
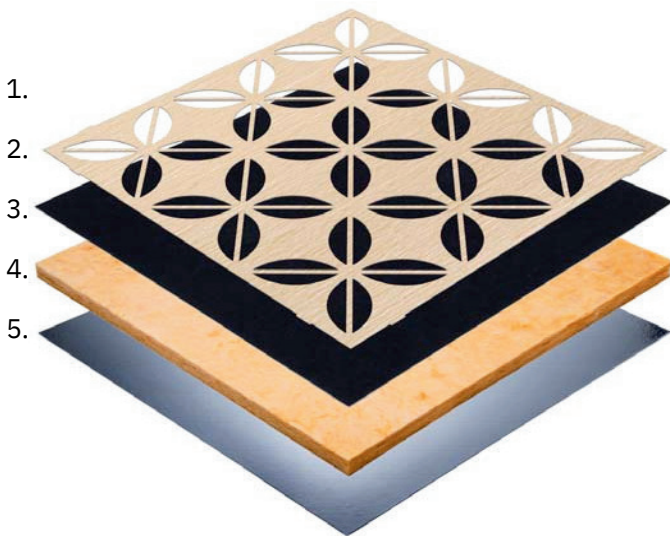
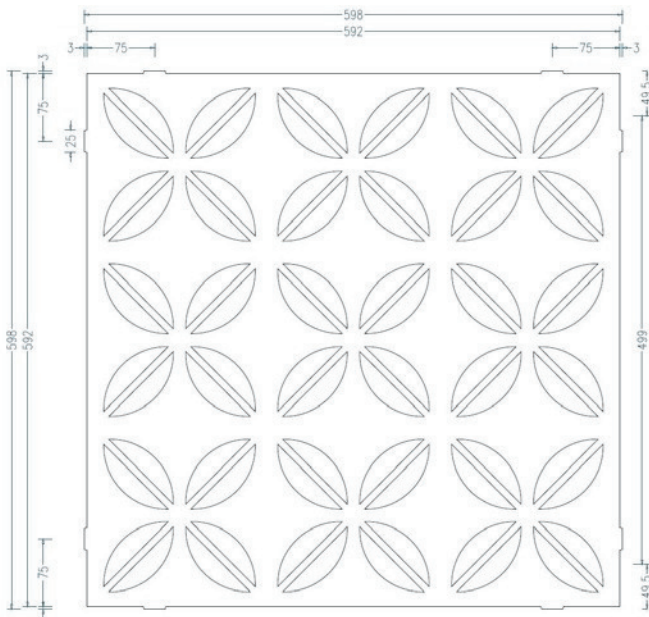

### Sizes: # FP100

600 x 600 mm or 600 x 1200 mm - frangipani perforation

### How to select your Sonaris™ laminate ceiling:

1. Select perforation panel size.
2. Select your surface colour/print (see Sonatex colour range datasheet).
3. Choose your base colour. (see Sonatex colour range datasheet).
4. Select your base panel type: Triton Range (Glass Fibre), Polyfon Range (Polyester).
5. Optional: Noise attenuation backer.

### Specification:

Acoustic ceiling panel shall be Asona (Triton) (Polyfon) size: (600 x 600mm), (600 x 1200mm), with Sonaris™ perforation pattern #FP100, surface colour: (white) (other), Base colour: (white) (other) with (optional) attenuation backer, as manufactured by Asona Ltd, +64 (9) 525 6575, info@asona.co.nz.

Ref. Sonaris #FP100-1710

Patent No. NZ2009208100

Patent No. AU570507

ISO 9001:2015 Registered Firm No. NZ1014

© 2023 Copyright ASONA Ltd Asona, Sonatex and Sonaris are trade marks of Asona Ltd. All dimensions are nominal. We reserve the right to change specifications. Ref. Sonatex and Sonaris-24.10

Asona Ltd.  
Office and Factory  
6 Mahunga Drive, Māngere  
Bridge, Auckland 2022  
New Zealand

Contact  
T: +64(0)9 525 6575  
E: info@asona.co.nz  
W: www.asona.co.nz  
NZBN: 9429036035175

**asona**



# Sonaris™ #S4-25

## Perforated acoustic ceiling panel laminate finish

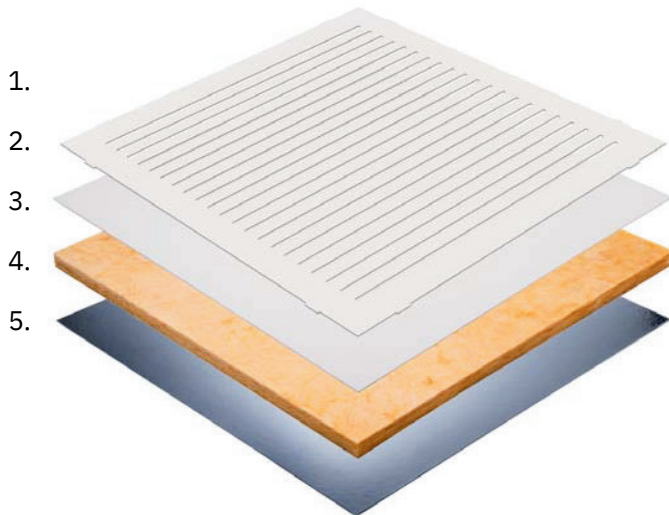
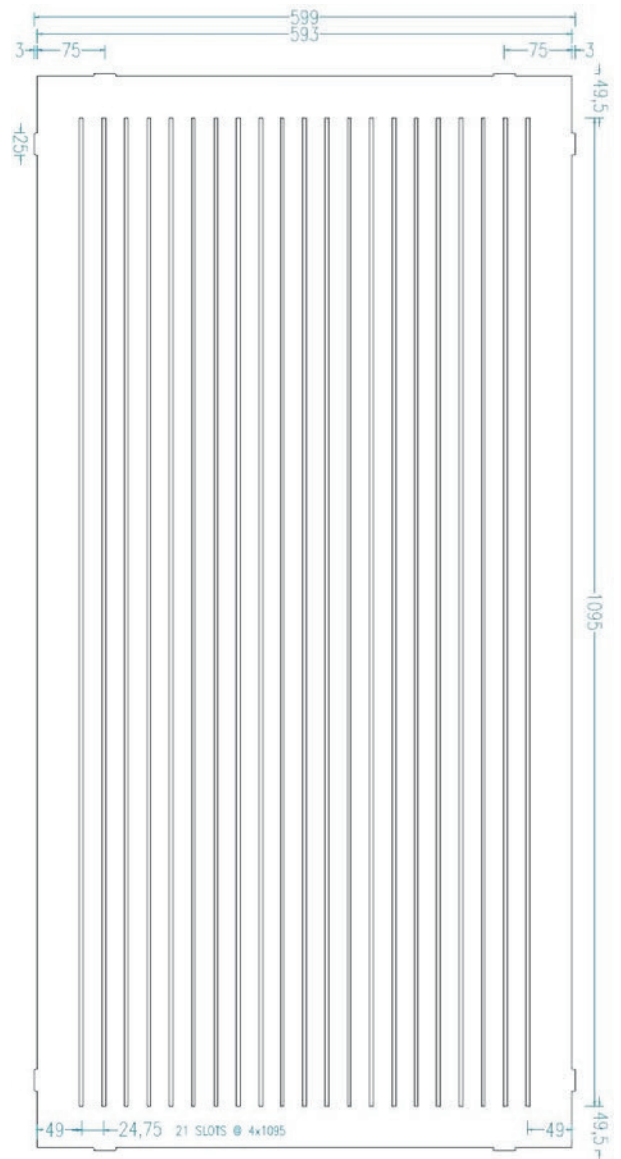
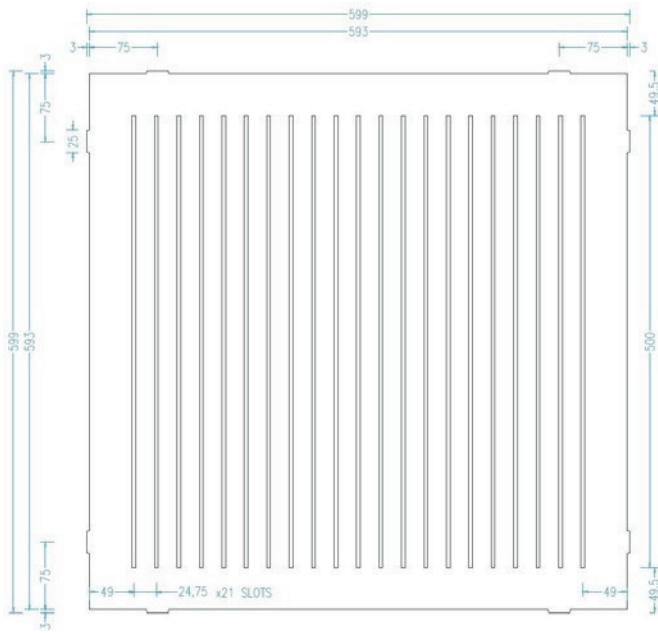

### Sizes: #S4-25

4 x 500mm slot @ 25mm centres 600 x 600mm  
 4 x 1100mm slot @ 25mm centres 600 x 1200mm

### How to select your Sonaris™ laminate ceiling:

1. Select perforation panel size.
2. Select your surface colour/print (see Sonatex colour range datasheet).
3. Choose your base colour. (see Sonatex colour range datasheet).
4. Select your base panel type: Triton Range (Glass Fibre), Polyfon Range (Polyester).
5. Optional: Noise attenuation backer.

### Specification:

Acoustic ceiling panel shall be Asona (Triton) (Polyfon) size: (600 x 600mm), (600 x 1200mm), with Sonaris™ perforation pattern #S4- 25, surface colour: (white) (other), Base colour: (white) (other) with (optional) attenuation backer, as manufactured by Asona Ltd, +64 (9) 525 6575, info@asona.co.nz.

Ref. Sonaris #S4-25-1710

Patent No. NZ2009208100

Patent No. AU570507

ISO 9001:2015 Registered Firm No. NZ1014

© 2023 Copyright ASONA Ltd Asona, Sonatex and Sonaris are trade marks of Asona Ltd.  
 All dimensions are nominal. We reserve the right to change specifications.  
 Ref. Sonatex and Sonaris-24.10

Asona Ltd.  
 Office and Factory  
 6 Mahunga Drive, Māngere  
 Bridge, Auckland 2022  
 New Zealand

Contact  
 T: +64(0)9 525 6575  
 E: info@asona.co.nz  
 W: www.asona.co.nz  
 NZBN: 9429036035175



# Sonaris™ #4040H Hexagonal

## Perforated acoustic ceiling panel laminate finish

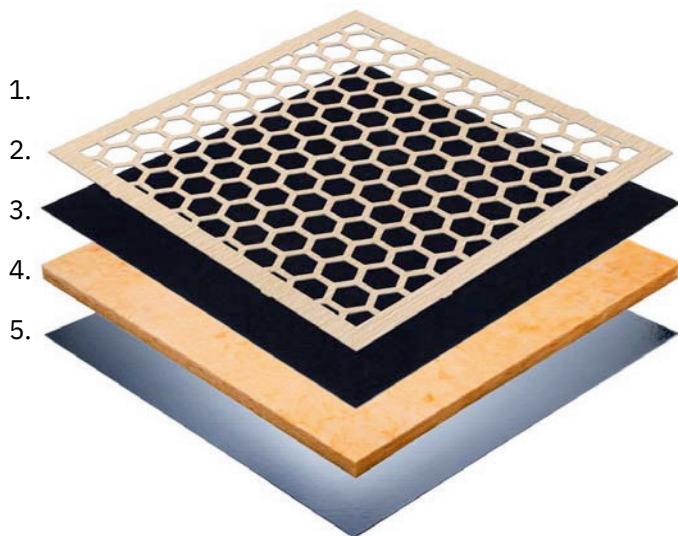
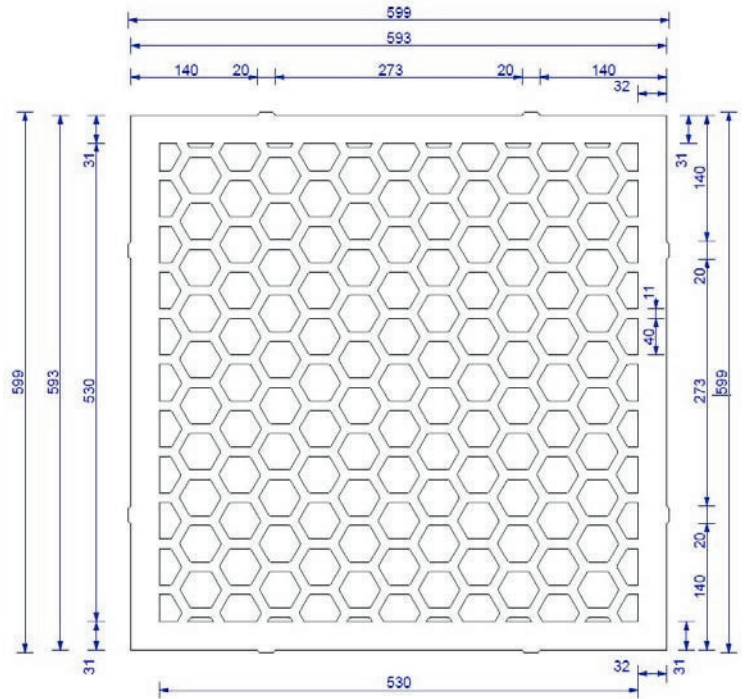

**Sizes: #4040H**  
600 x 600 mm, 40 x 40 mm Hexagon Perforation

### How to select your Sonaris™ laminate ceiling:

1. Select perforation panel size.
2. Select your surface colour/print (see Sonatex colour range datasheet).
3. Choose your base colour. (see Sonatex colour range datasheet).
4. Select your base panel type: Triton Range (Glass Fibre), Polyfon Range (Polyester).
5. Optional: Noise attenuation backer.

### Specification:

Acoustic ceiling panel shall be Asona (Triton) (Polyfon) size: (600 x 600mm), with Sonaris™ perforation pattern #4040H, surface colour: (white) (other), Base colour: (white) (other) with (optional) attenuation backer, as manufactured by Asona Ltd, +64 (9) 525 6575, [info@asona.co.nz](mailto:info@asona.co.nz).

Ref. Sonaris #4040H-1710

Patent No. NZ2009208100

Patent No. AU570507

ISO 9001:2015 Registered Firm No. NZ1014

© 2023 Copyright ASONA Ltd Asona, Sonatex and Sonaris are trade marks of Asona Ltd.  
All dimensions are nominal. We reserve the right to change specifications.  
Ref. Sonatex and Sonaris-24.10

Asona Ltd.  
Office and Factory  
6 Mahunga Drive, Māngere  
Bridge, Auckland 2022  
New Zealand

Contact  
T: +64(0)9 525 6575  
E: [info@asona.co.nz](mailto:info@asona.co.nz)  
W: [www.asona.co.nz](http://www.asona.co.nz)  
NZBN: 9429036035175

**asona**



# Sonaris™ #4071D Diamond

## Perforated acoustic ceiling panel laminate finish

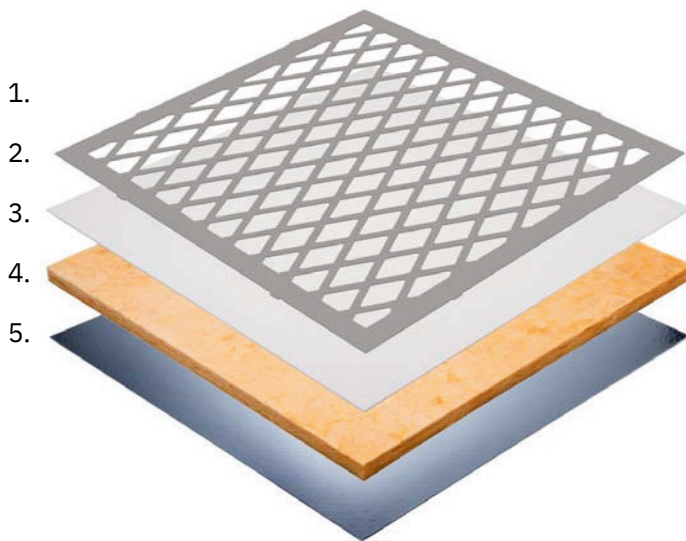
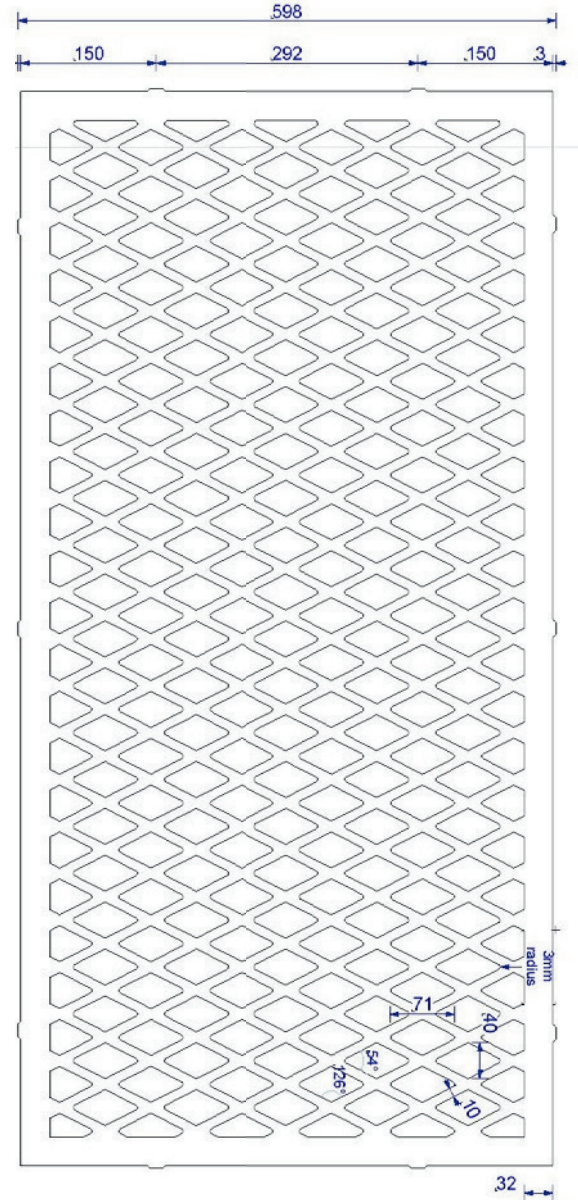
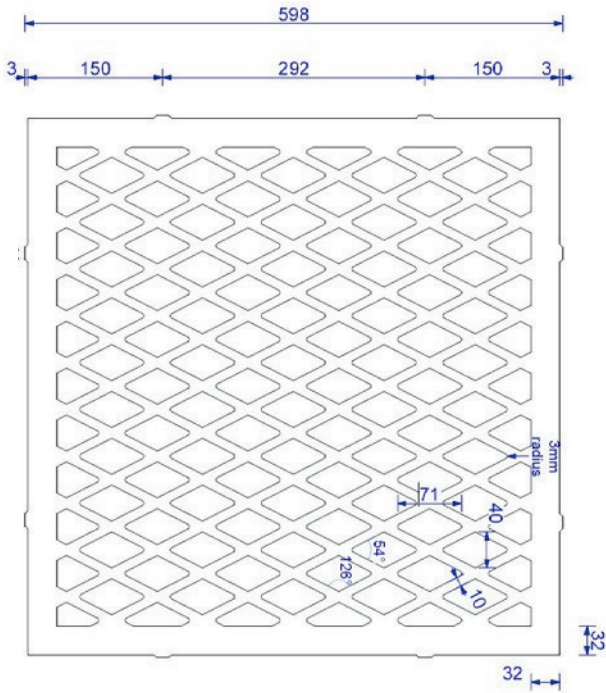

### Sizes: #4071D

600 x 600 mm or 600 x 1200 mm - Diamond Perforation

### How to select your Sonaris™ laminate ceiling:

1. Select perforation panel size.
2. Select your surface colour/print (see Sonatex colour range datasheet).
3. Choose your base colour. (see Sonatex colour range datasheet).
4. Select your base panel type: Triton Range (Glass Fibre), Polyfon Range (Polyester).
5. Optional: Noise attenuation backer.

### Specification:

Acoustic ceiling panel shall be Asona (Triton) (Polyfon) size: (600 x 600mm), (600 x 1200mm), with Sonaris™ perforation pattern #4071D, surface colour: (white) (other), Base colour: (white) (other) with (optional) attenuation backer, as manufactured by Asona Ltd, +64 (9) 525 6575, [info@asona.co.nz](mailto:info@asona.co.nz).

Ref. Sonaris #4071D-1710

Patent No. NZ2009208100

Patent No. AU570507

ISO 9001:2015 Registered Firm No. NZ1014

© 2023 Copyright ASONA Ltd Asona, Sonatex and Sonaris are trade marks of Asona Ltd. All dimensions are nominal. We reserve the right to change specifications. Ref. Sonatex and Sonaris-24.10

Asona Ltd.  
Office and Factory  
6 Mahunga Drive, Māngere  
Bridge, Auckland 2022  
New Zealand

Contact  
T: +64(0)9 525 6575  
E: [info@asona.co.nz](mailto:info@asona.co.nz)  
W: [www.asona.co.nz](http://www.asona.co.nz)  
NZBN: 9429036035175

**asona**

# Sonaris™ #250/25HB

## Perforated acoustic ceiling panel laminate finish

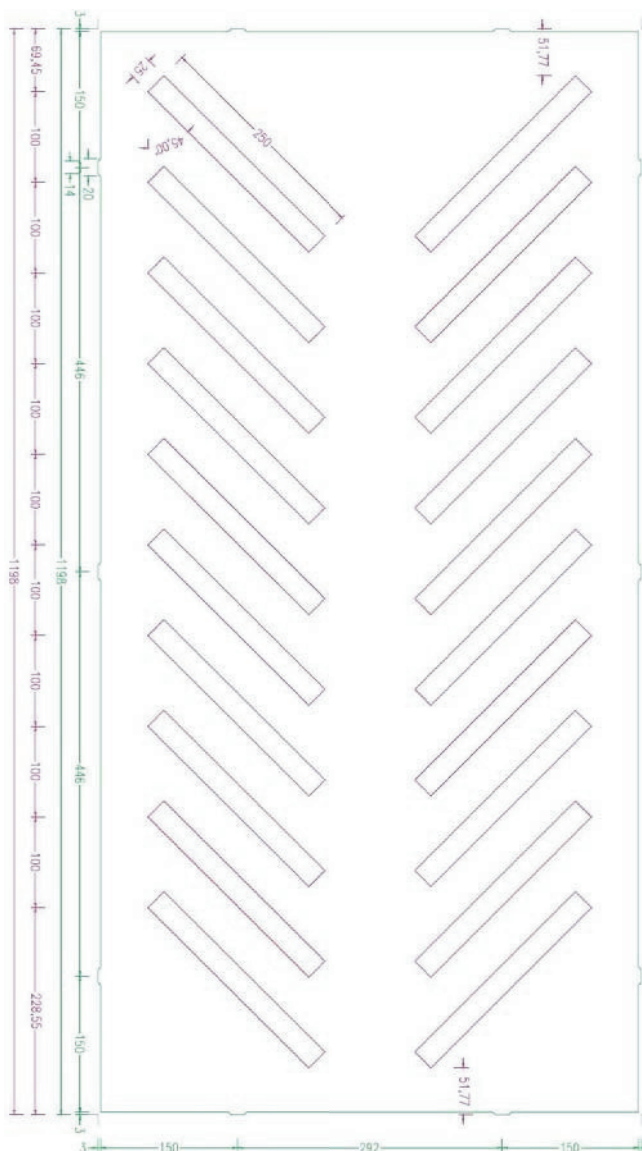
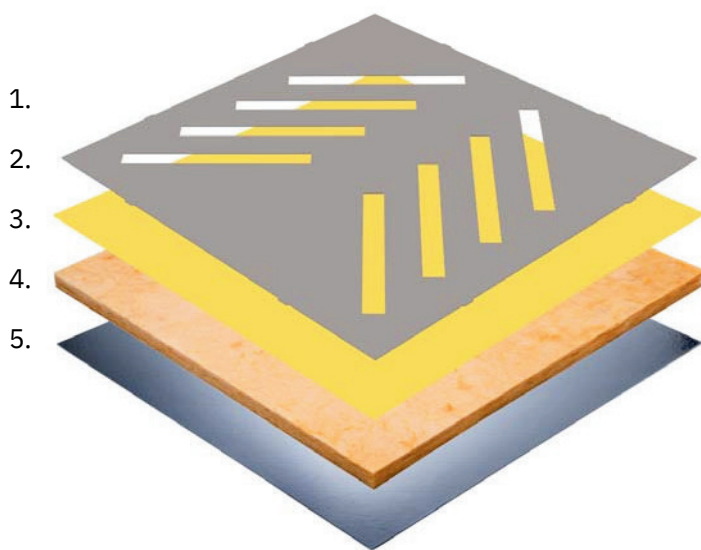

### Sizes: #250/25HB

600 x 1200 mm , 250 x 25mm Herringbone slot perforation

### How to select your Sonaris™ laminate ceiling:

1. Select perforation panel size.
2. Select your surface colour/print (see Sonatex colour range datasheet).
3. Choose your base colour. (see Sonatex colour range datasheet).
4. Select your base panel type: Triton Range (Glass Fibre), Polyfon Range (Polyester).
5. Optional: Noise attenuation backer.

### Specification:

Acoustic ceiling panel shall be Asona (Triton) (Polyfon) size: (600 x 1200mm), with Sonaris™ perforation pattern #250/25HB, surface colour: (white) (other), Base colour: (white) (other) with (optional) attenuation backer, as manufactured by Asona Ltd, +64 (9) 525 6575, info@asona.co.nz.

Ref. Sonaris #250/25HB-1710

Patent No. NZ2009208100

Patent No. AU570507

ISO 9001:2015 Registered Firm No. NZ1014

© 2023 Copyright ASONA Ltd Asona, Sonatex and Sonaris are trade marks of Asona Ltd.

All dimensions are nominal. We reserve the right to change specifications.

Ref. Sonatex and Sonaris-24.10

Asona Ltd.  
Office and Factory  
6 Mahunga Drive, Māngere  
Bridge, Auckland 2022  
New Zealand

Contact  
T: +64(0)9 525 6575  
E: info@asona.co.nz  
W: www.asona.co.nz  
NZBN: 9429036035175

**asona**



# Sonaris™ #163040R

## Perforated acoustic ceiling panel laminate finish

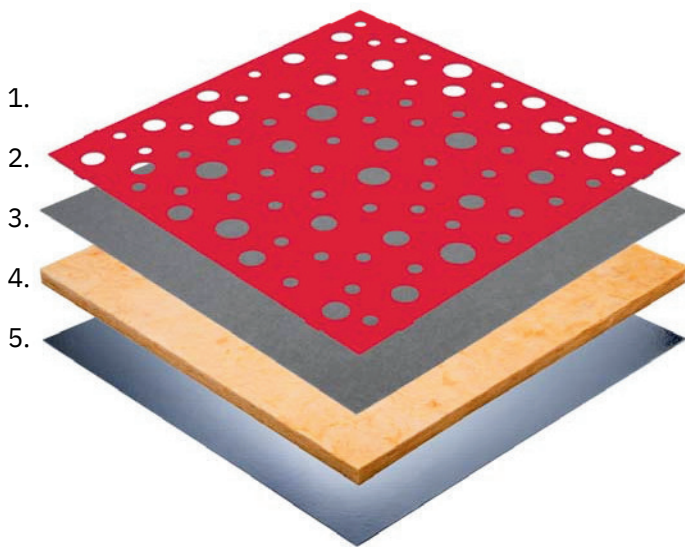
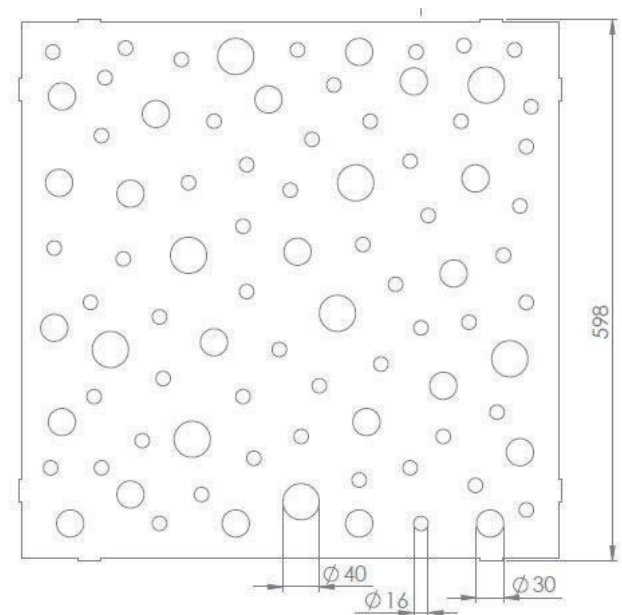

### Sizes: #163040R

600 x 600 mm, 16/30/40mm random hole perforation

### How to select your Sonaris™ laminate ceiling:

1. Select perforation panel size.
2. Select your surface colour/print (see Sonatex colour range datasheet).
3. Choose your base colour. (see Sonatex colour range datasheet).
4. Select your base panel type: Triton Range (Glass Fibre), Polyfon Range (Polyester).
5. Optional: Noise attenuation backer.

### Specification:

Acoustic ceiling panel shall be Asona (Triton) (Polyfon) size: (600 x 600mm), with Sonaris™ perforation pattern #163040R, surface colour: (white) (other), Base colour: (white) (other) with (optional) attenuation backer, as manufactured by Asona Ltd, +64 (9) 525 6575, info@asona.co.nz.

Ref. Sonaris #163040R-1710

Patent No. NZ2009208100

Patent No. AU570507

ISO 9001:2015 Registered Firm No. NZ1014

© 2023 Copyright ASONA Ltd Asona, Sonatex and Sonaris are trade marks of Asona Ltd.

All dimensions are nominal. We reserve the right to change specifications.

Ref. Sonatex and Sonaris-24.10

Asona Ltd.  
Office and Factory  
6 Mahunga Drive, Māngere  
Bridge, Auckland 2022  
New Zealand

Contact  
T: +64(0)9 525 6575  
E: info@asona.co.nz  
W: www.asona.co.nz  
NZBN: 9429036035175

**asona**

# Sonaris™ #S10-100

## Perforated acoustic ceiling panel laminate finish

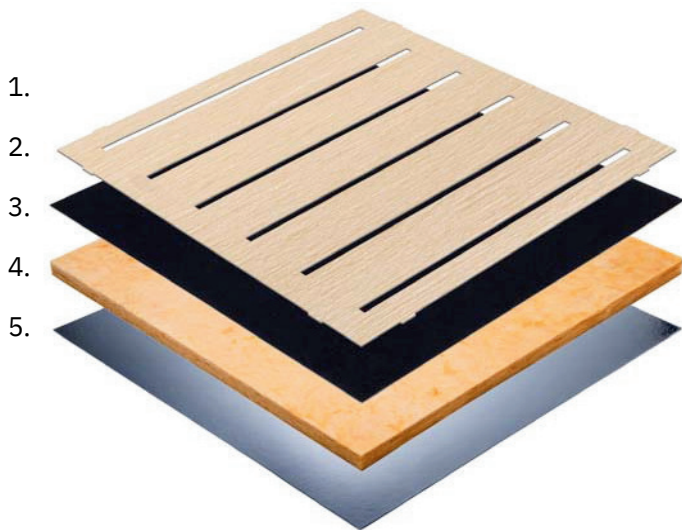
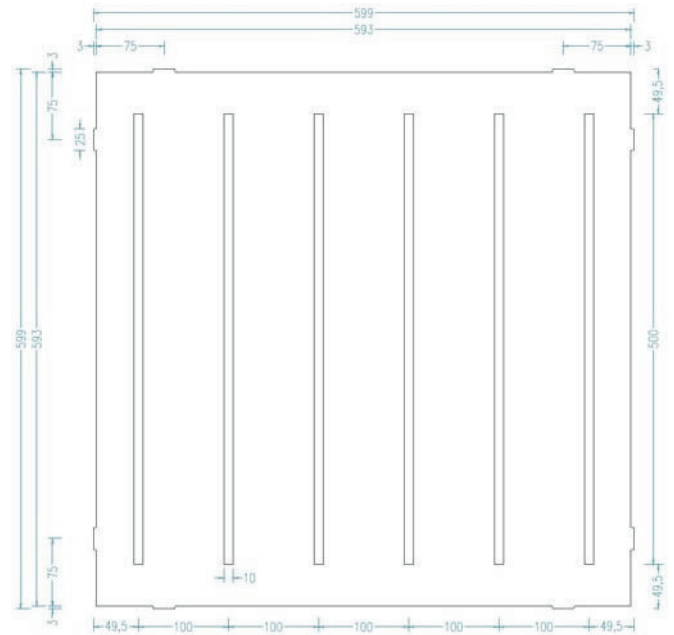

### Sizes: #S10-100

600 x 600 mm, 10 x 100mm Slot perforation

### How to select your Sonaris™ laminate ceiling:

1. Select perforation panel size.
2. Select your surface colour/print (see Sonatex colour range datasheet).
3. Choose your base colour. (see Sonatex colour range datasheet).
4. Select your base panel type: Triton Range (Glass Fibre), Polyfon Range (Polyester).
5. Optional: Noise attenuation backer.

### Specification:

Acoustic ceiling panel shall be Asona (Triton) (Polyfon) size: (600 x 600mm), with Sonaris™ perforation pattern #S10-100, surface colour: (white) (other), Base colour: (white) (other) with (optional) attenuation backer, as manufactured by Asona Ltd, +64 (9) 525 6575, [info@asona.co.nz](mailto:info@asona.co.nz).

Ref. Sonaris #S10-100-1710

Patent No. NZ2009208100

Patent No. AU570507

ISO 9001:2015 Registered Firm No. NZ1014

© 2023 Copyright ASONA Ltd Asona, Sonatex and Sonaris are trade marks of Asona Ltd.

All dimensions are nominal. We reserve the right to change specifications.

Ref. Sonatex and Sonaris-24.10

Asona Ltd.  
Office and Factory  
6 Mahunga Drive, Māngere  
Bridge, Auckland 2022  
New Zealand

Contact  
T: +64(0)9 525 6575  
E: [info@asona.co.nz](mailto:info@asona.co.nz)  
W: [www.asona.co.nz](http://www.asona.co.nz)  
NZBN: 9429036035175

**asona**



# Sonaris™ #S7-75

## Perforated acoustic ceiling panel laminate finish

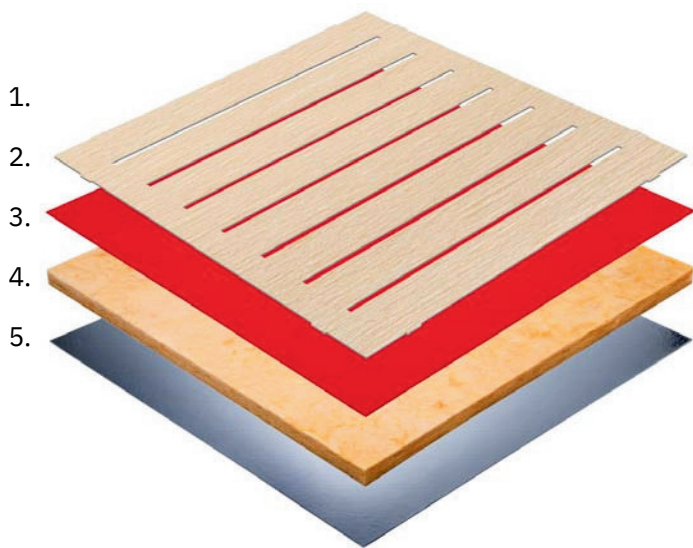
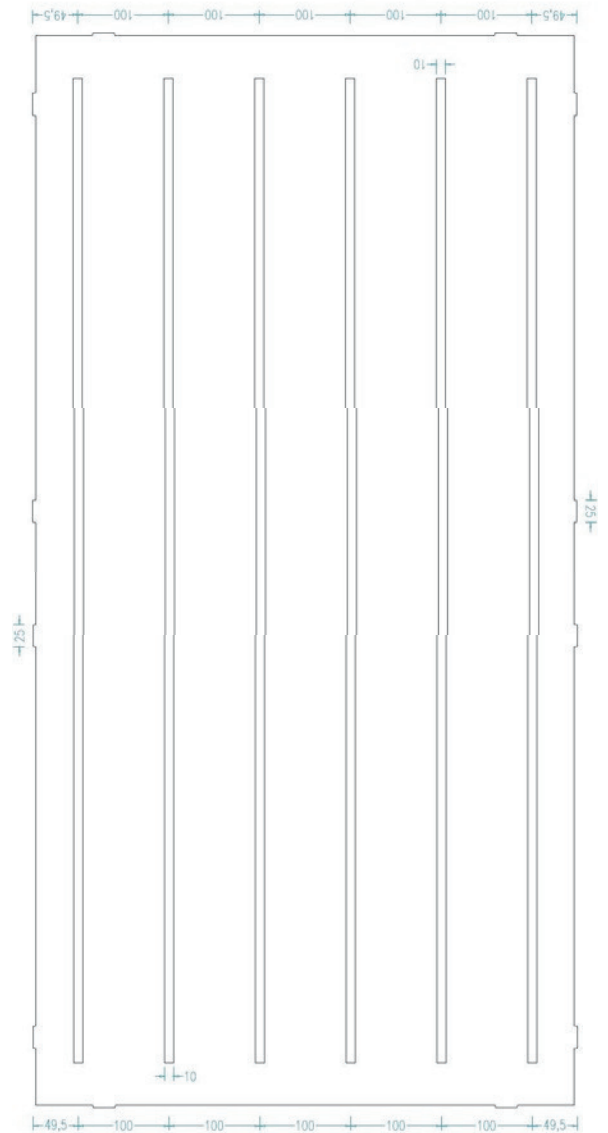
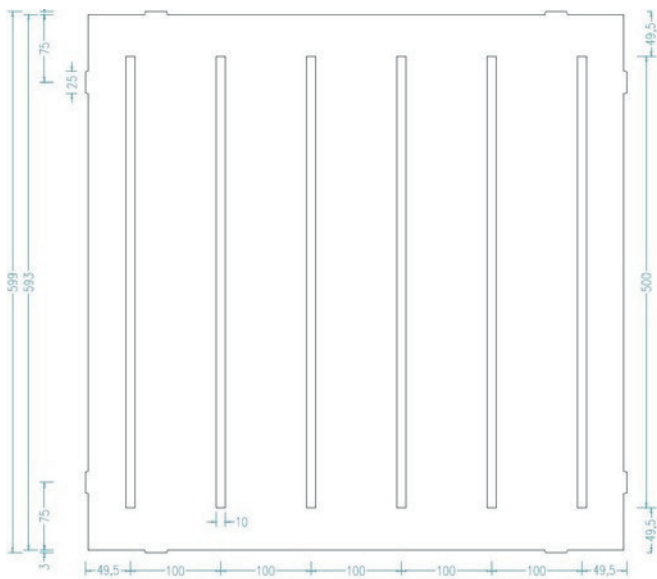

### Sizes: #S7-75

600 x 600 mm, 600 x 1200mm, 7 x 75mm slot perforation.

### How to select your Sonaris™ laminate ceiling:

1. Select perforation panel size.
2. Select your surface colour/print (see Sonatex colour range datasheet).
3. Choose your base colour. (see Sonatex colour range datasheet).
4. Select your base panel type: Triton Range (Glass Fibre), Polyfon Range (Polyester).
5. Optional: Noise attenuation backer.

### Specification:

Acoustic ceiling panel shall be Asona (Triton) (Polyfon) size: (600 x 600mm), (600 x 1200mm), with Sonaris™ perforation pattern #S7-75, surface colour: (white) (other), Base colour: (white) (other) with (optional) attenuation backer, as manufactured by Asona Ltd, +64 (9) 525 6575, info@asona.co.nz.

Ref. Sonaris #S7-75-1710

Patent No. NZ2009208100

Patent No. AU570507

ISO 9001:2015 Registered Firm No. NZ1014

© 2023 Copyright ASONA Ltd Asona, Sonatex and Sonaris are trade marks of Asona Ltd. All dimensions are nominal. We reserve the right to change specifications. Ref. Sonatex and Sonaris-24.10

Asona Ltd.  
Office and Factory  
6 Mahunga Drive, Māngere  
Bridge, Auckland 2022  
New Zealand

Contact  
T: +64(0)9 525 6575  
E: info@asona.co.nz  
W: www.asona.co.nz  
NZBN: 9429036035175

**asona**

# Sonaris™ #RSlot Perforated Facing

## Perforated acoustic ceiling panel laminate finish

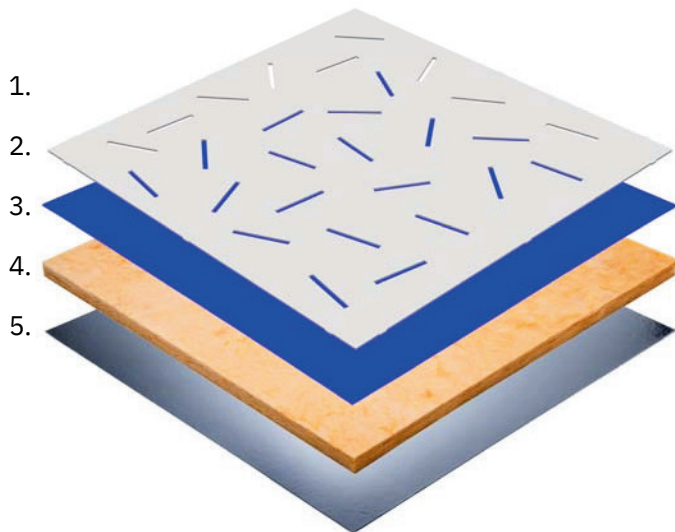
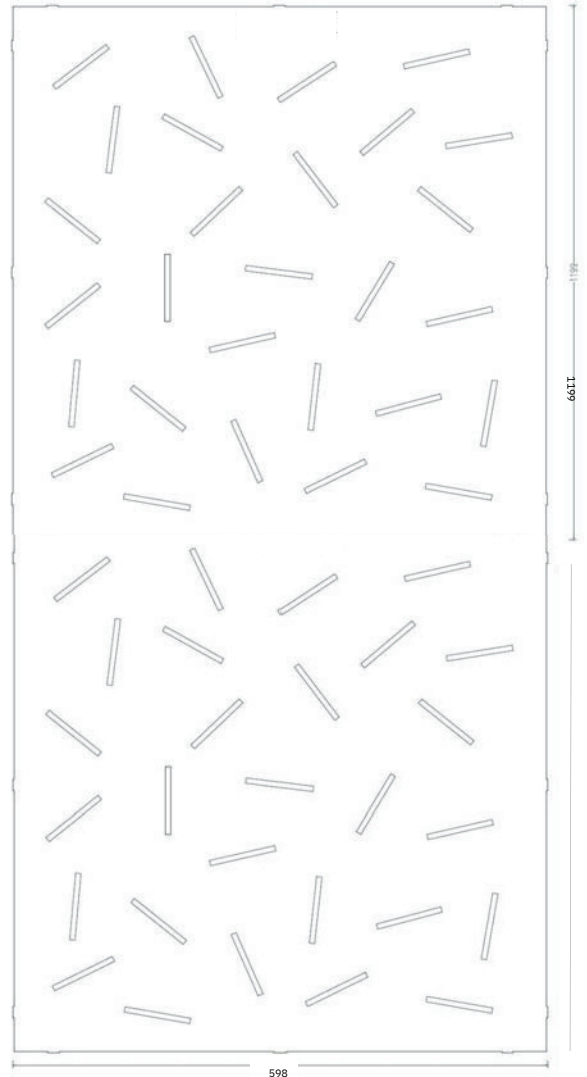
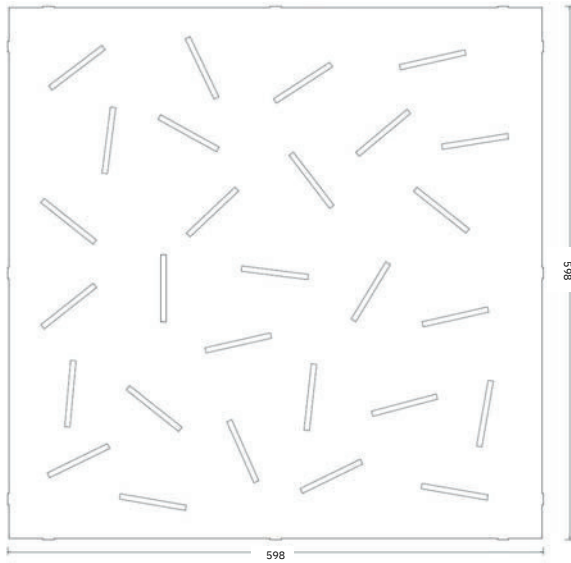

### Sizes: # RSlot

600 x 600mm, 600 x 1200mm, 1200 x 1200mm  
10 x 150mm random slot perforation.

### How to select your Sonaris™ laminate ceiling:

1. Select perforation panel size.
2. Select your surface colour/print (see Sonatex colour range datasheet).
3. Choose your base colour. (see Sonatex colour range datasheet).
4. Select your base panel type: Triton Range (Glass Fibre), Polyfon Range (Polyester).
5. Optional: Noise attenuation backer.

### Specification:

Acoustic ceiling panel shall be Asona (Triton) (Polyfon) size: (600 x 600mm), (600 x 1200mm), (1200 x 1200mm) with Sonaris™ perforation pattern #RSlot, surface colour: (white) (other), Base colour: (white) (other) with (optional) attenuation backer, as manufactured by Asona Ltd, +64 (9) 525 6575, info@asona.co.nz.

Ref. Sonaris #RSlot-1710

Patent No. NZ2009208100

Patent No. AU570507

ISO 9001:2015 Registered Firm No. NZ1014

© 2023 Copyright ASONA Ltd Asona, Sonatex and Sonaris are trade marks of Asona Ltd.  
All dimensions are nominal. We reserve the right to change specifications.  
Ref. Sonatex and Sonaris-24.10

Asona Ltd.  
Office and Factory  
6 Mahunga Drive, Māngere  
Bridge, Auckland 2022  
New Zealand

Contact  
T: +64(0)9 525 6575  
E: info@asona.co.nz  
W: www.asona.co.nz  
NZBN: 9429036035175

**asona**



## Sonatex™ - Acoustic Laminate Shades, Colours and Prints

### White to Black



A180 White



RAL 7040 Light Cool Grey



RAL 7030 Mid Warm Grey



RAL 9002 Off White Grey



RAL 7045 Mid Cool Grey

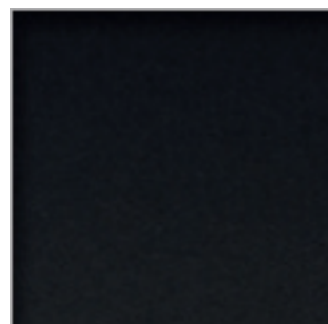

RAL 9011 Black

### Prints

(not to scale)



Wood print RAL 1013

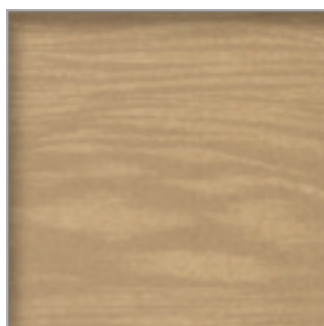

Wood print RAL 1001 (TON 1127)

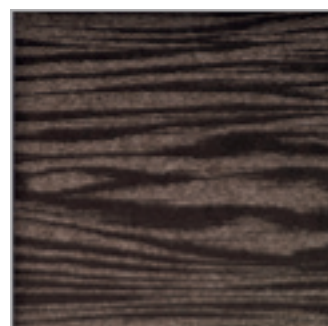

Wood print RAL 8019

Asona Sonatex is colour matched to the RAL Classic K7 range colours standard. The colour accuracy of this swatch card is dependent on your viewing screen and/or printer used.

Custom colours are available to order, minimum quantity applies.

Contact Asona for Sonatex samples:

Email: [info@asona.co.nz](mailto:info@asona.co.nz)

Phone: +64 (0) 9 525 6575

Minimum order quantity applies

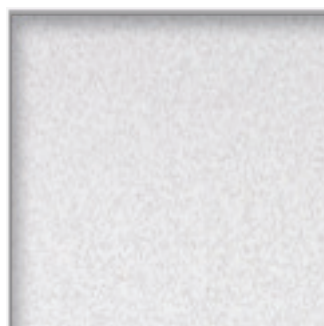

600 Stipple Print

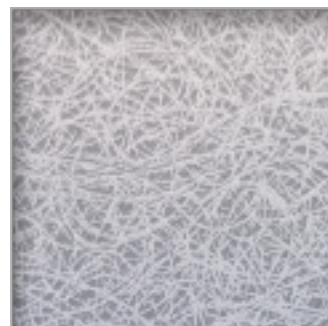

Woodwool print RAL 7040

## Sonatex™ - Acoustic Laminate Shades, Colours and Prints

### Soft Colours

Minimum order quantity may apply, speak to your Asona Consultant.

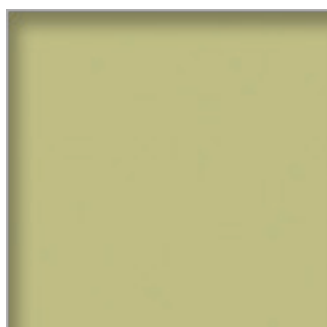

RAL 1000 Puka Green



RAL 4009 Egmont Grey



RAL 1001 Taupo Clay



RAL 1015 Oyster Bay



RAL 9018 Porirua Mist



RAL 3012 Flax Seed

### Bright Colours

Minimum order quantity may apply, speak to your Asona Consultant.

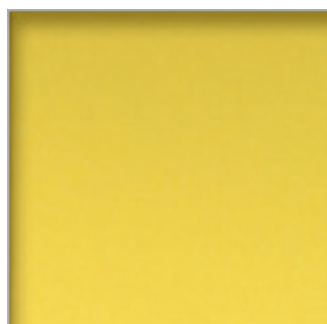

RAL 1018 Zinc Yellow

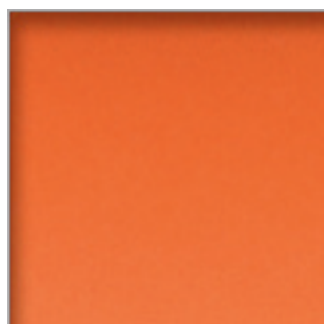

RAL 2009 Traffic Orange

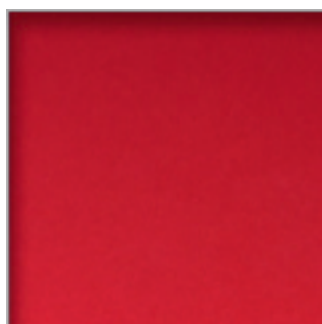

RAL 3020 Traffic Red

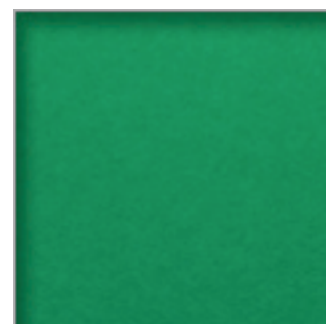

RAL 6032 Traffic Green

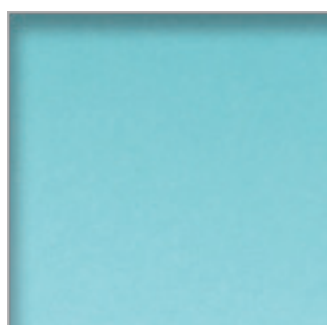

RAL 6027 Aqua



Cobalt Blue



RAL 1004 Gold



RAL 1014 Ivory

