

Ultratone™ Perforated GIB® Plasterboard

Item:	UL13.1224.8/18.W1L1
Perforations:	8mm holes @ 18.2mm centres
Sheet Size:	2400mm (L) x 1200mm (W)
Border:	58.5mm (L) & 59.1mm (W)
Open Area*:	13.19%

*Includes non perforated border.

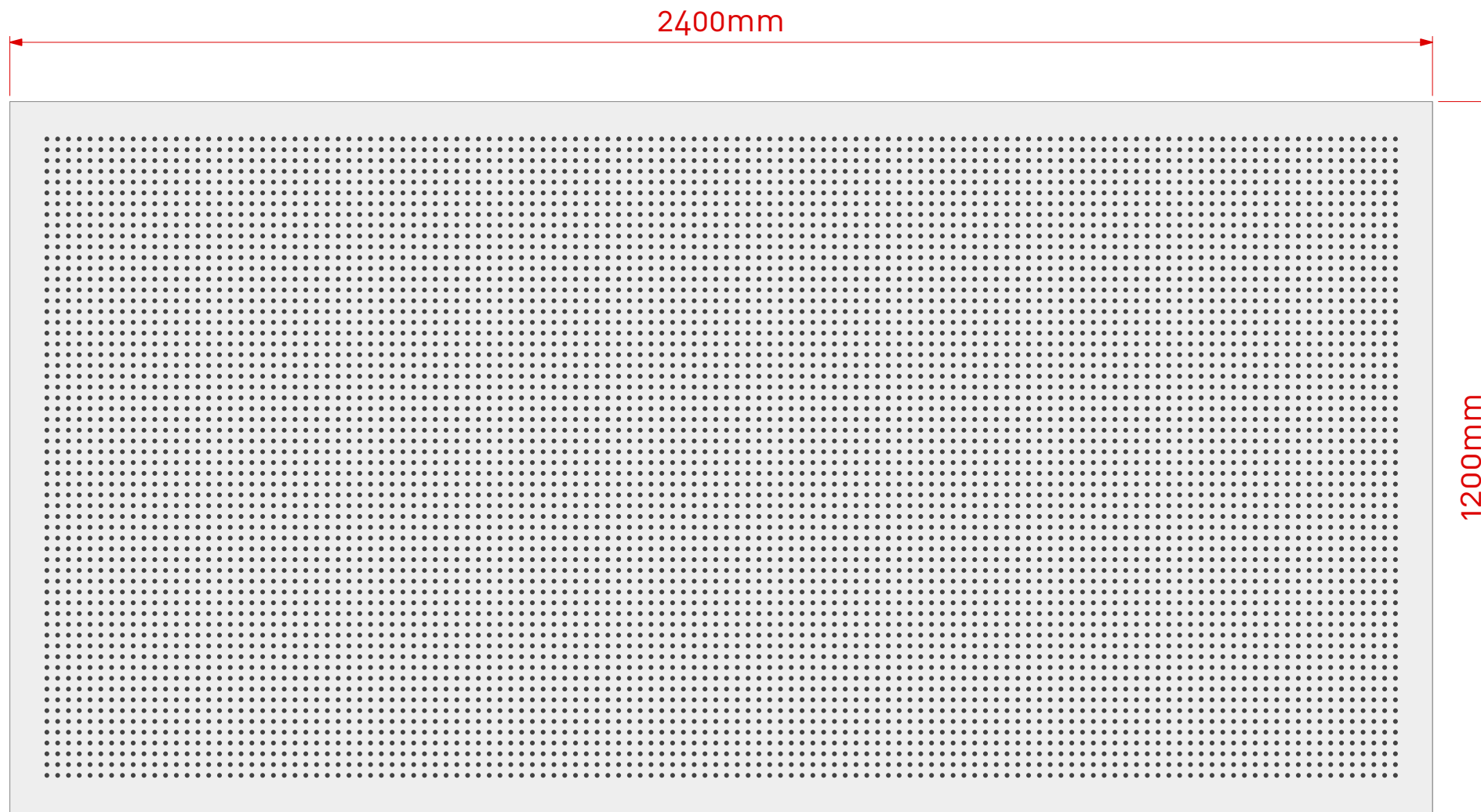

Scale 1:10 @ A3

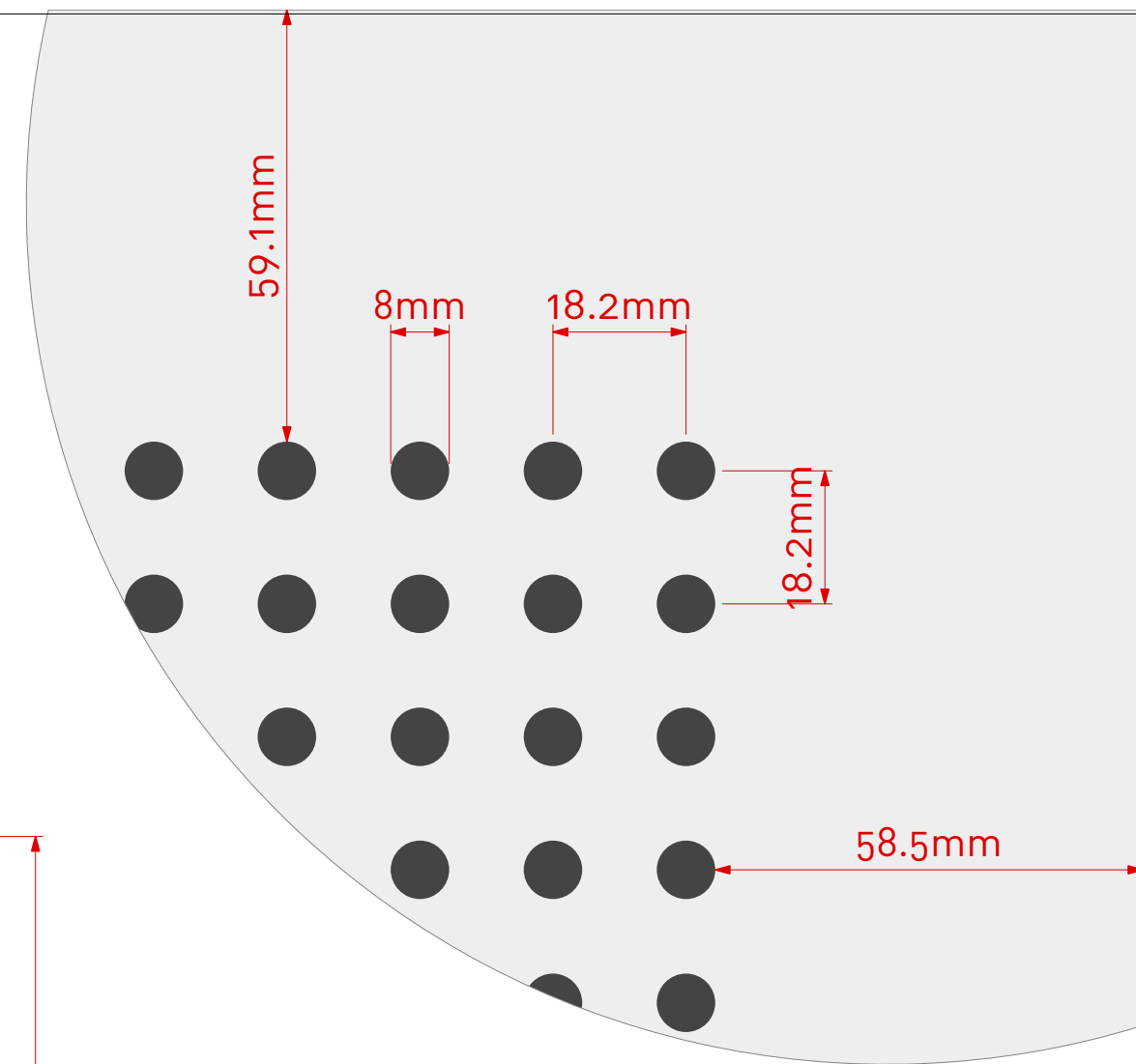

Scale 1:1 @ A3



Cluster Group

Note: Panel size, border and non perforated areas can be varied to suit project, consult Asona



www.asona.co.nz

info@asona.co.nz

6 Mahunga Drive, Mangere Bridge
Auckland 2022, New Zealand
Tel: +64 9 525 6575

Ultratone Perforated GIB® Plasterboard

Product: Ultratone GIB®

Customer:

Project Name:

Job Number: TBC

APPROVED

Date: / /

Name:

Sign:

NOTES

View: Face View

Drawing Number: UL13.1224.8/18.W1L1

Drawing Date: 10/10/24

Drawn: SL

Scale: 1:10 & 1:1

Ultratone™ Perforated GIB® Plasterboard

Item:	UL13.1224.8/18.W1L2
Perforations:	8mm hole @ 18.2mm centres
Sheet Size:	2400mm (L) x 1200mm (W)
Border:	58.5mm (L) & 29.1mm (W)
Open Area*:	12.57%

*Includes non perforated border.

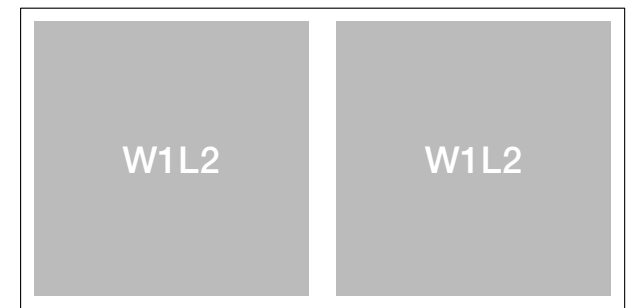
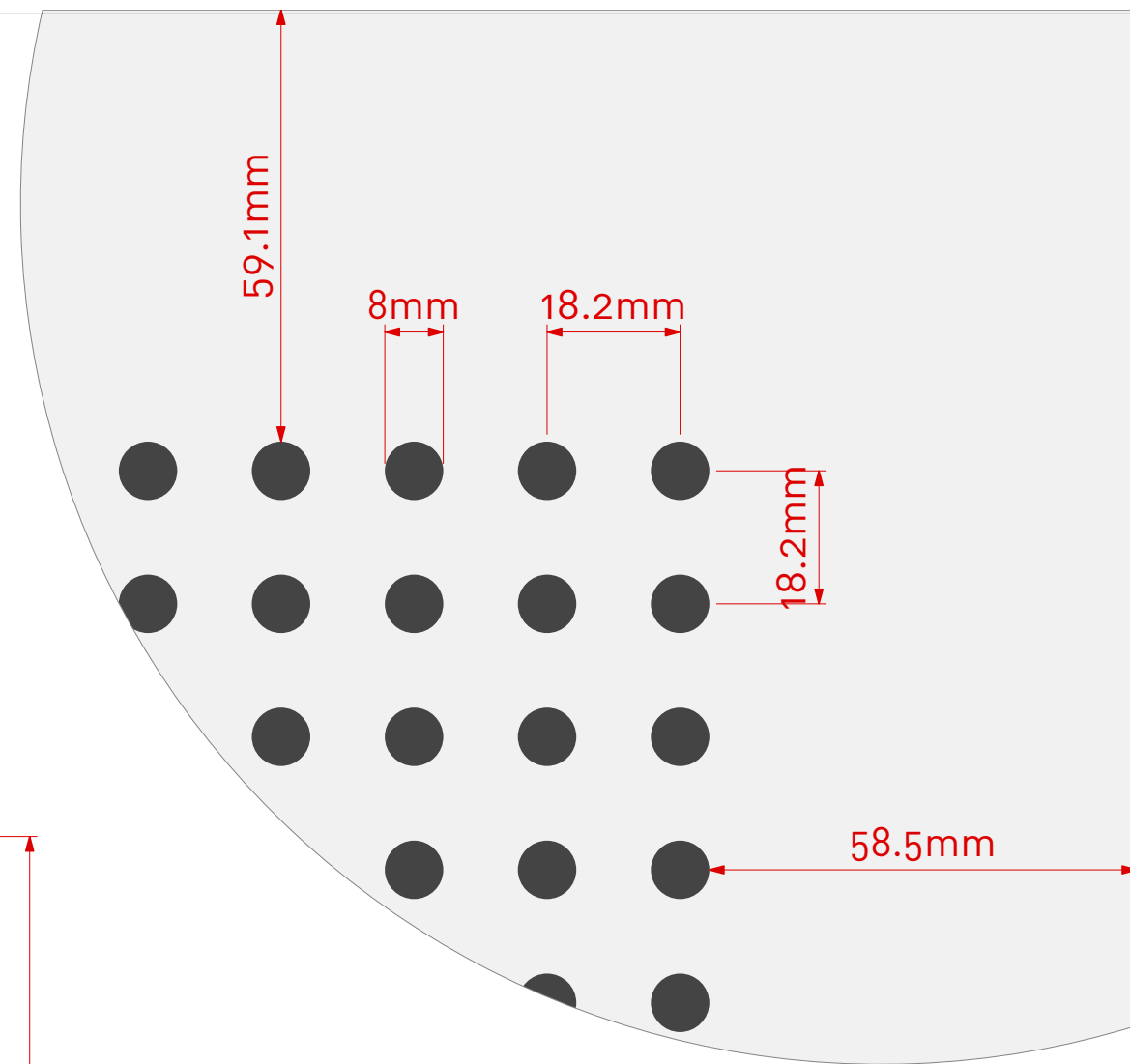
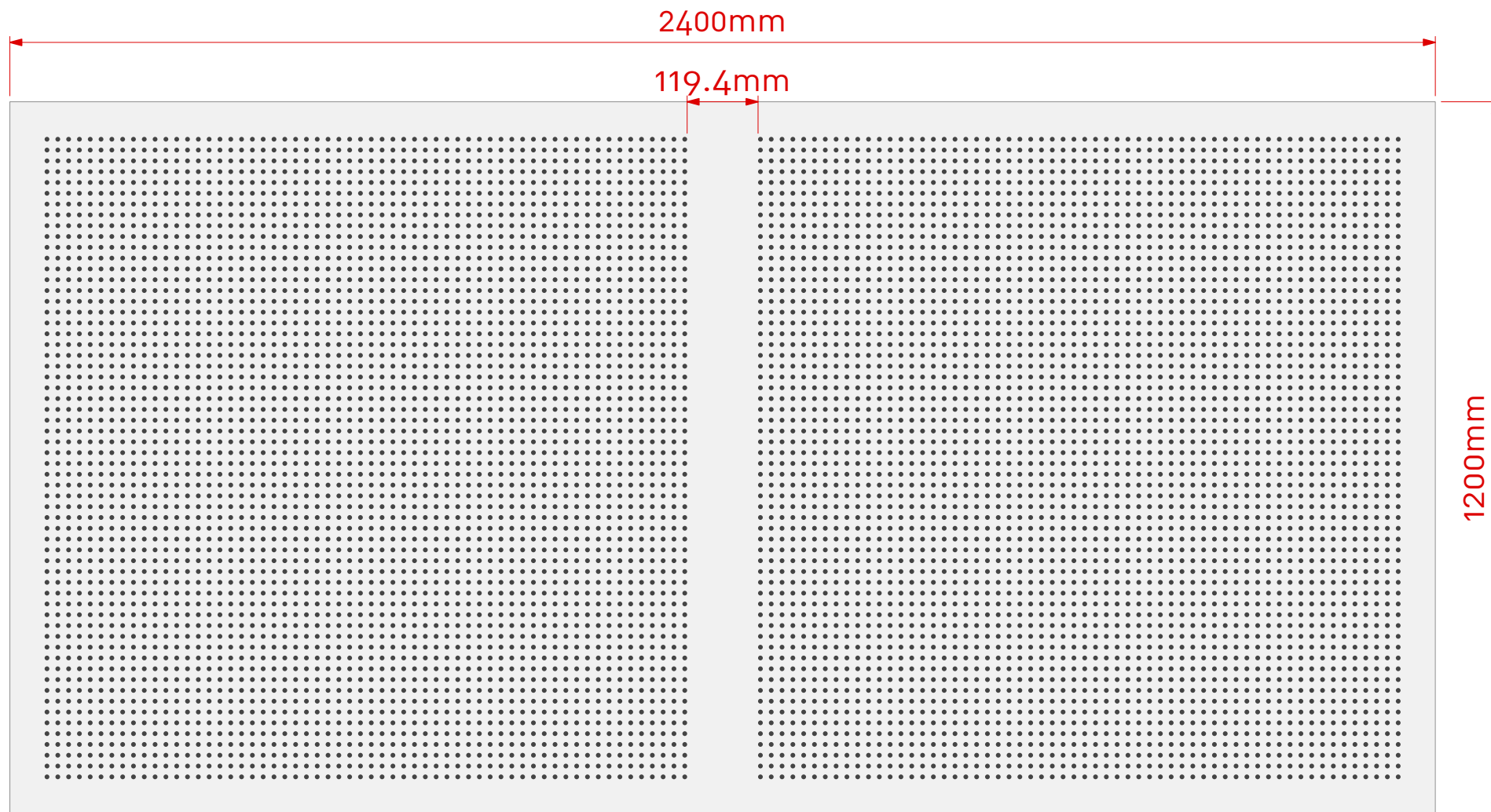

Cluster Group

Note: Panel size, border and non perforated areas can be varied to suit project, consult Asona

Scale 1:10 @ A3



www.asona.co.nz

info@asona.co.nz

6 Mahunga Drive, Mangere Bridge
Auckland 2022, New Zealand
Tel: +64 9 525 6575

Ultratone Perforated GIB® Plasterboard

Product: Ultratone GIB®

Customer:

Project Name:

Job Number: TBC

APPROVED

Date: / /

Name:

Sign:

NOTES

View: Face View

Drawing Number: UL13.1224.8/18.W1L2

Drawing Date: 10/10/24

Drawn: SL

Scale: 1:10 & 1:1

Ultratone™ Perforated GIB® Plasterboard

Item:	UL13.1224.8/18.W2L1
Perforations:	8mm hole @ 18.2mm centres
Sheet Size:	2400mm (L) x 1200mm (W)
Border:	58.5mm (L) & 59.1mm (W)
Open Area*:	11.88%

*Includes non perforated border.

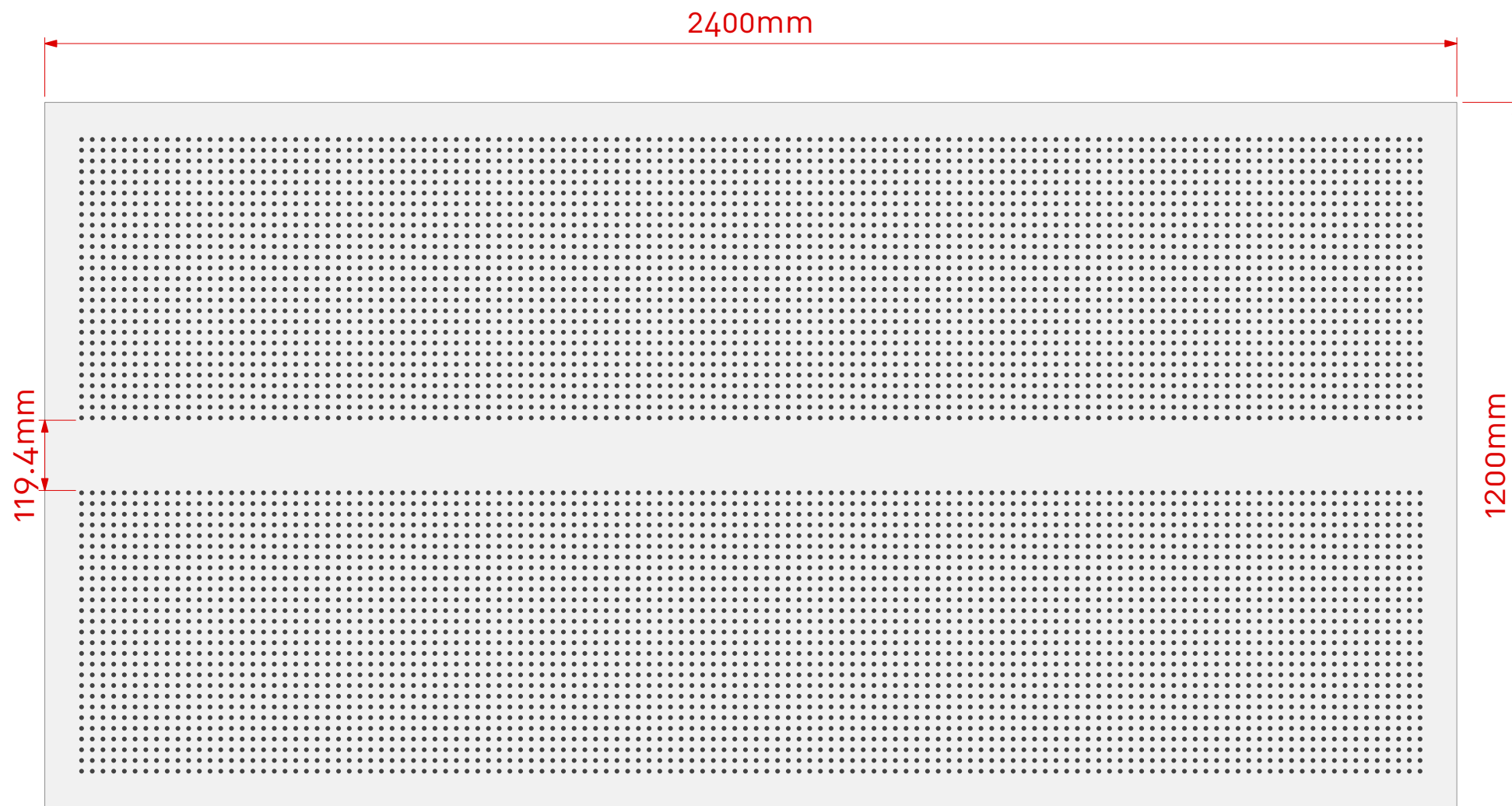

Note: Panel size, border and non perforated areas can be varied to suit project, consult Asona

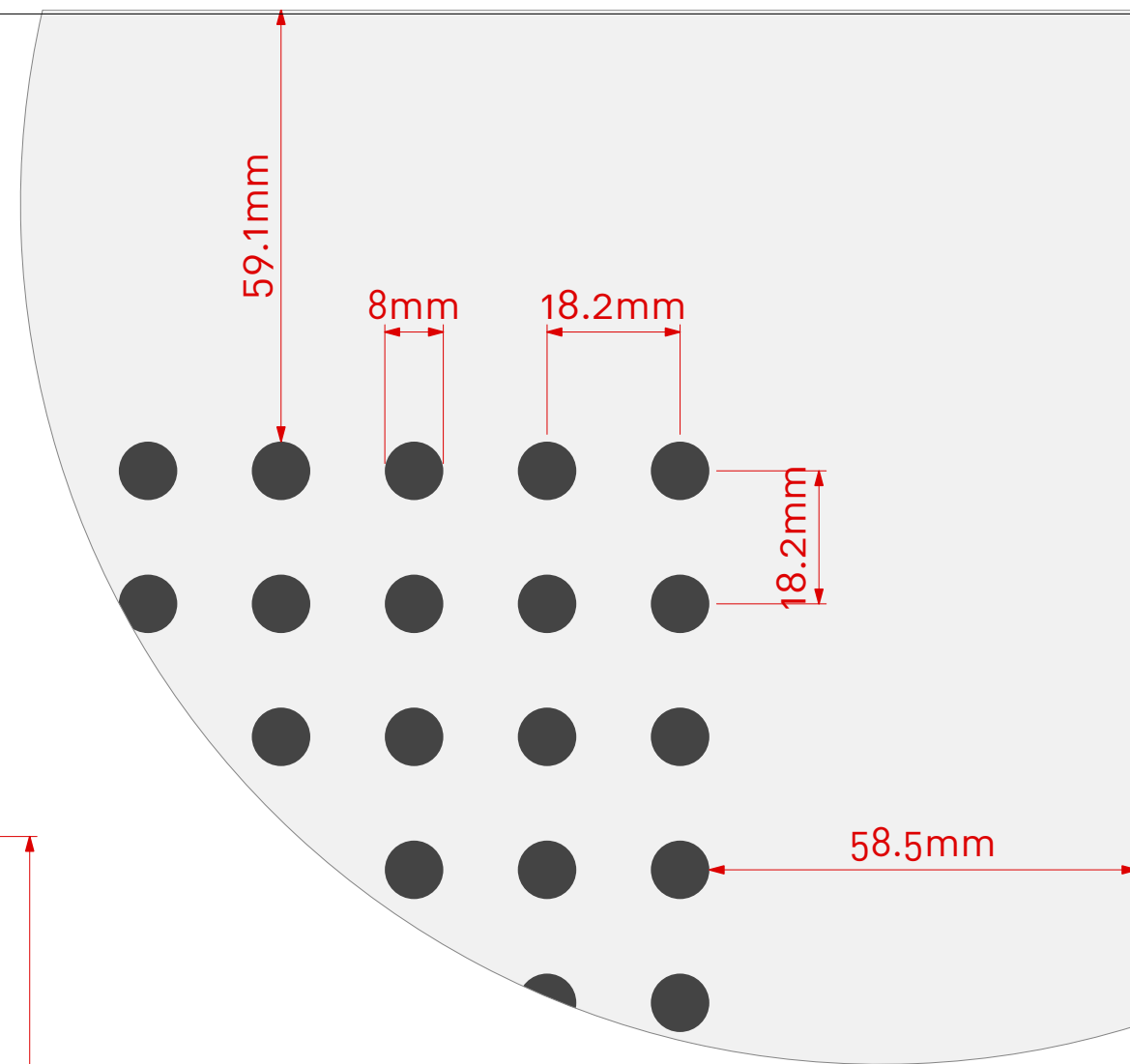

Cluster Group



www.asona.co.nz

info@asona.co.nz

6 Mahunga Drive, Mangere Bridge
Auckland 2022, New Zealand
Tel: +64 9 525 6575

Ultratone Perforated GIB® Plasterboard

Product:	Ultratone GIB®
Customer:	
Project Name:	
Job Number:	TBC

APPROVED
Date: / /
Name:
Sign:

NOTES

View: Face View

Drawing Number:	UL13.1224.8/18.W2L1
Drawing Date:	10/10/24
Drawn:	SL
Scale:	1:10 & 1:1

Ultratone™ Perforated GIB® Plasterboard

Item:	UL13.1224.8/18.W2L2
Perforations:	8mm hole @ 18mm centres
Sheet Size:	2400mm (L) x 1200mm (W)
Border:	62mm (L) & 56mm (W)
Open Area*:	11.31%

*Includes non perforated border.

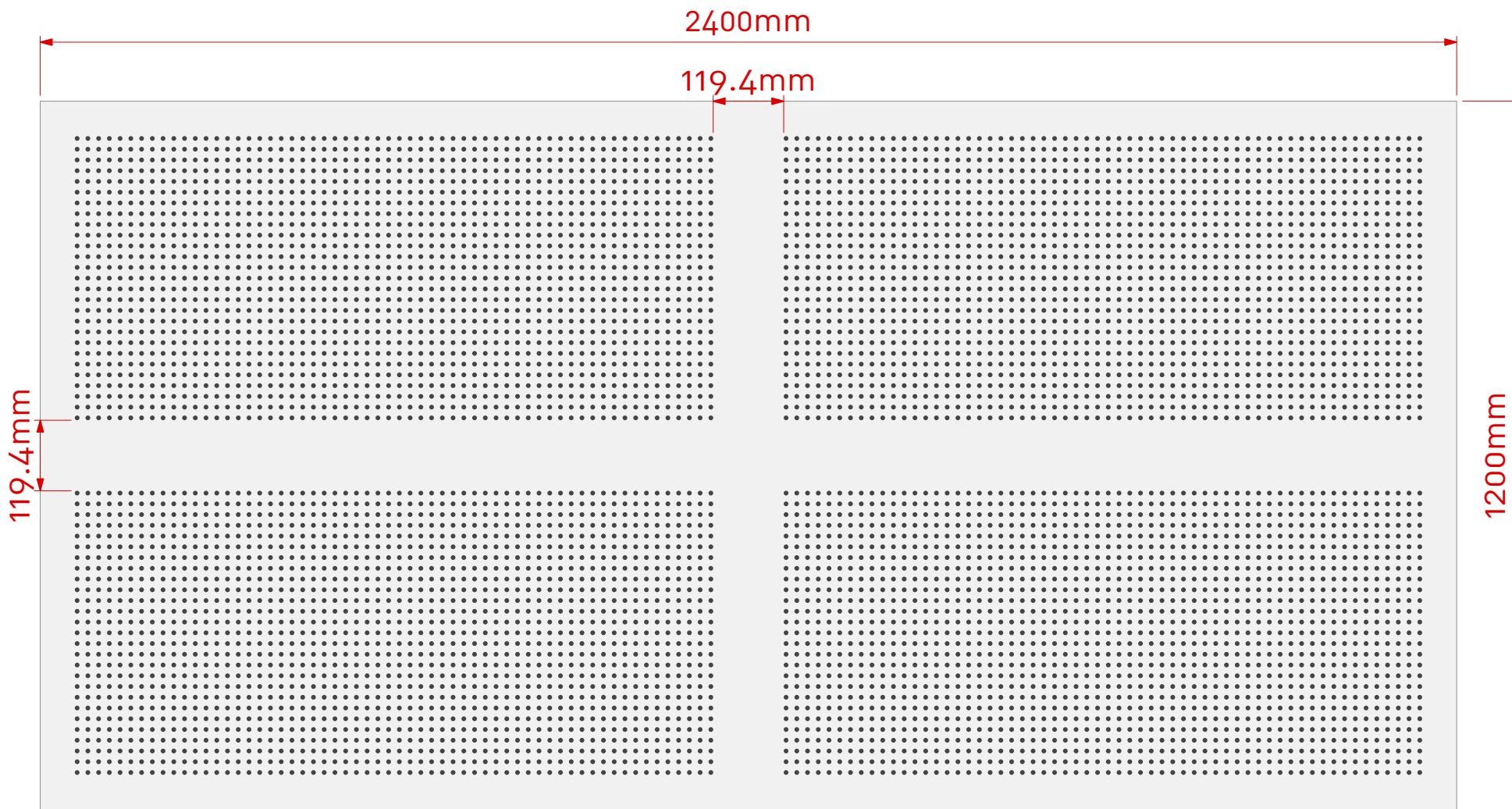

Note: Panel size, border and non perforated areas can be varied to suit project, consult Asona

Scale 1:10 @ A3

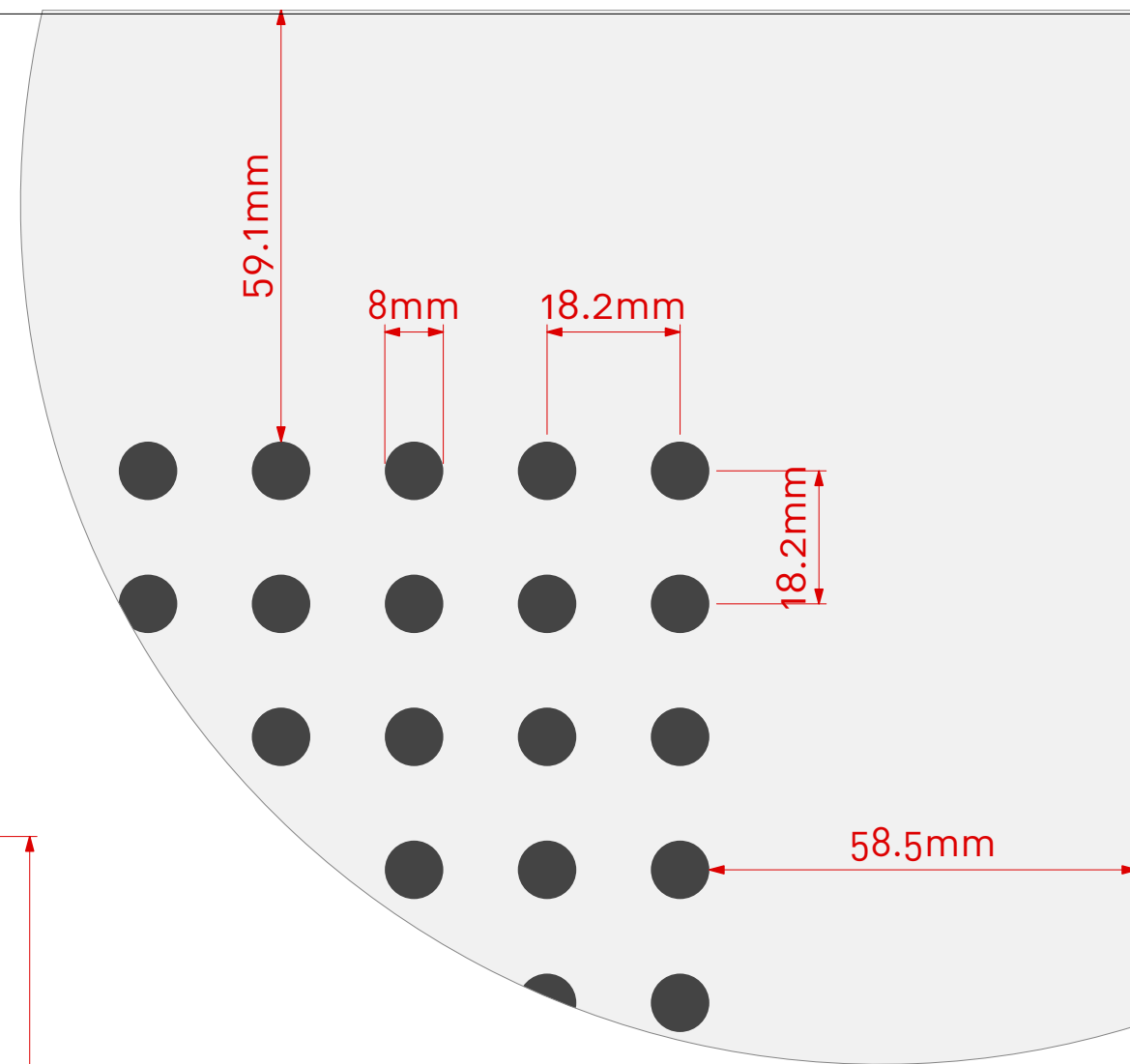

Scale 1:1 @ A3

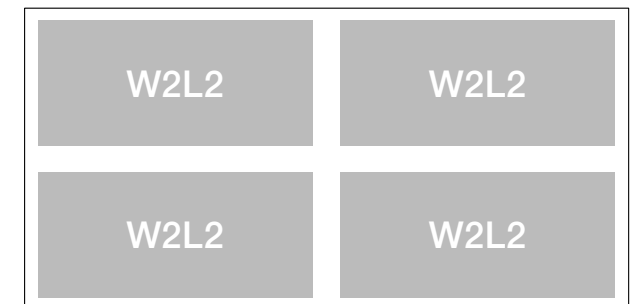

Cluster Group



www.asona.co.nz

info@asona.co.nz

6 Mahunga Drive, Mangere Bridge
Auckland 2022, New Zealand
Tel: +64 9 525 6575

Ultratone Perforated GIB® Plasterboard

Product: Ultratone GIB®

Customer:

Project Name:

Job Number: TBC

APPROVED

Date: / /

Name:

Sign:

NOTES

View: Face View

Drawing Number: UL13.1224.8/18.W2L2

Drawing Date: 10/10/24

Drawn: SL

Scale: 1:10 & 1:1

Ultratone™ Perforated GIB® Plasterboard

Item:	UL13.1224.8/18.W2L4
Perforations:	8mm hole @ 18.2mm centres
Sheet Size:	2400mm (L) x 1200mm (W)
Border:	58.5mm (L) & 59.1mm (W)
Open Area*:	10.18%

*Includes non perforated border.

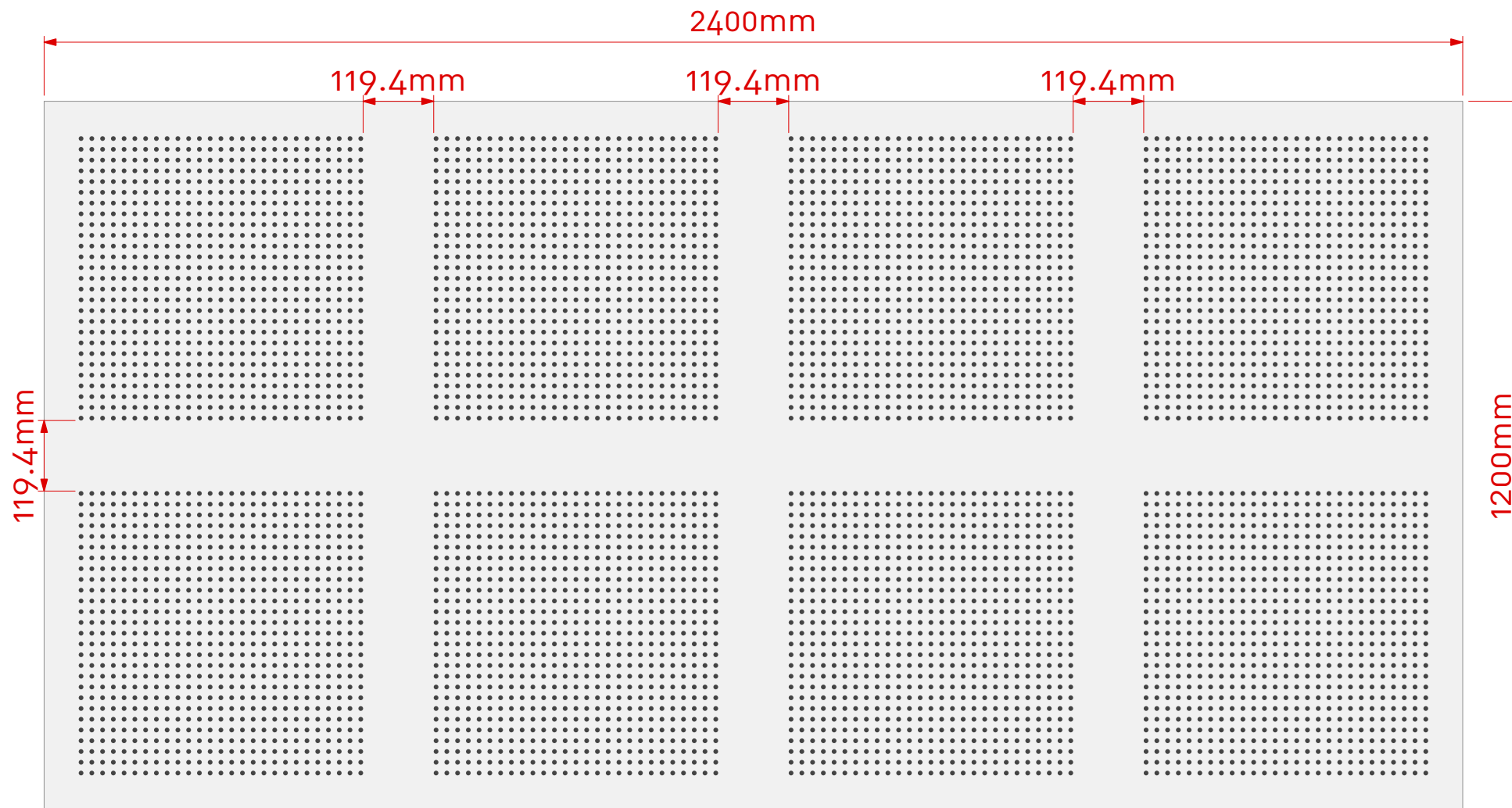

Note: Panel size, border and non perforated areas can be varied to suit project, consult Asona

Scale 1:10 @ A3

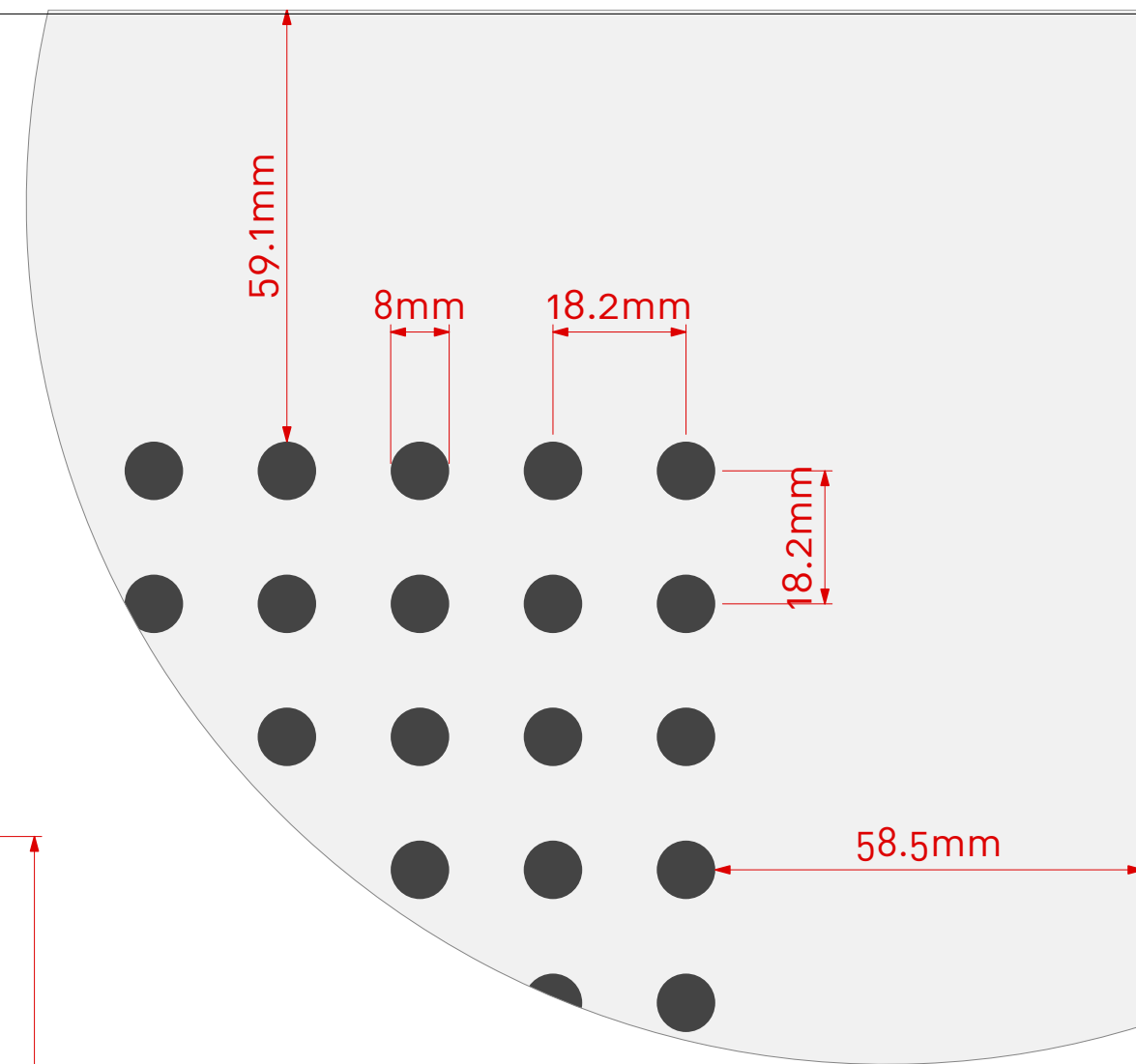

Scale 1:1 @ A3



Cluster Group



www.asona.co.nz

info@asona.co.nz

6 Mahunga Drive, Mangere Bridge
Auckland 2022, New Zealand
Tel: +64 9 525 6575

Ultratone Perforated GIB® Plasterboard

Product:	Ultratone GIB®
Customer:	
Project Name:	
Job Number:	TBC

APPROVED
Date: / /
Name:
Sign:

NOTES

View: Face View

Drawing Number:	UL13.1224.8/18.W2L4
Drawing Date:	10/10/24
Drawn:	SL
Scale:	1:10 & 1:1

Ultratone™ Perforated GIB® Plasterboard

Item:	UL13.1224.8/18.W3L1
Perforations:	8mm hole @ 18.2mm centres
Sheet Size:	2400mm (L) x 1200mm (W)
Border:	58.5mm (L) & 59.1mm (W)
Open Area*:	10.56%

*Includes non perforated border.

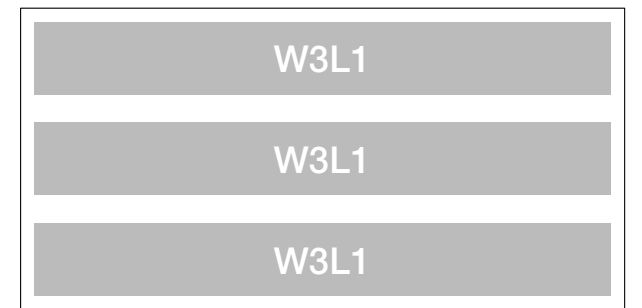
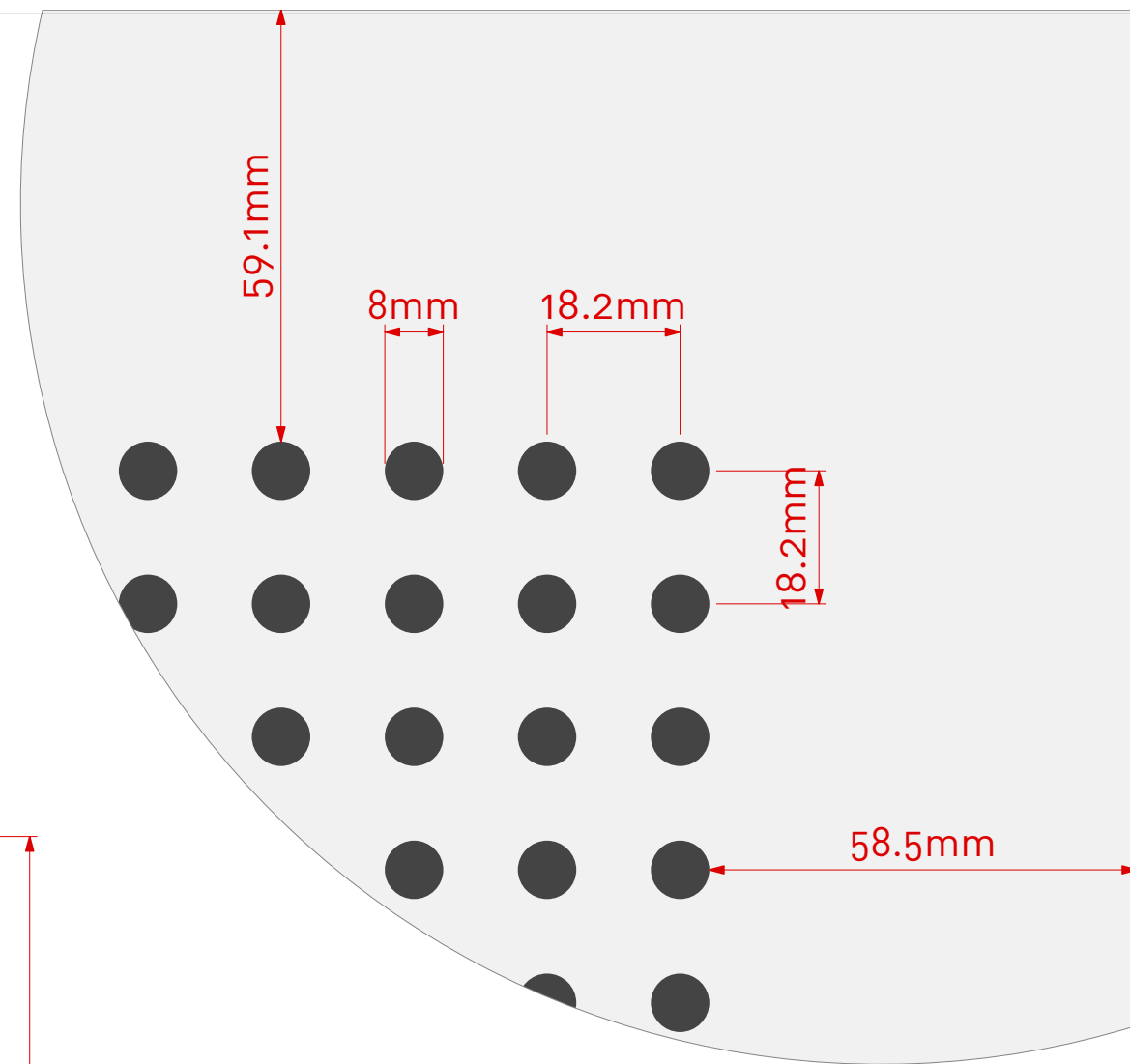
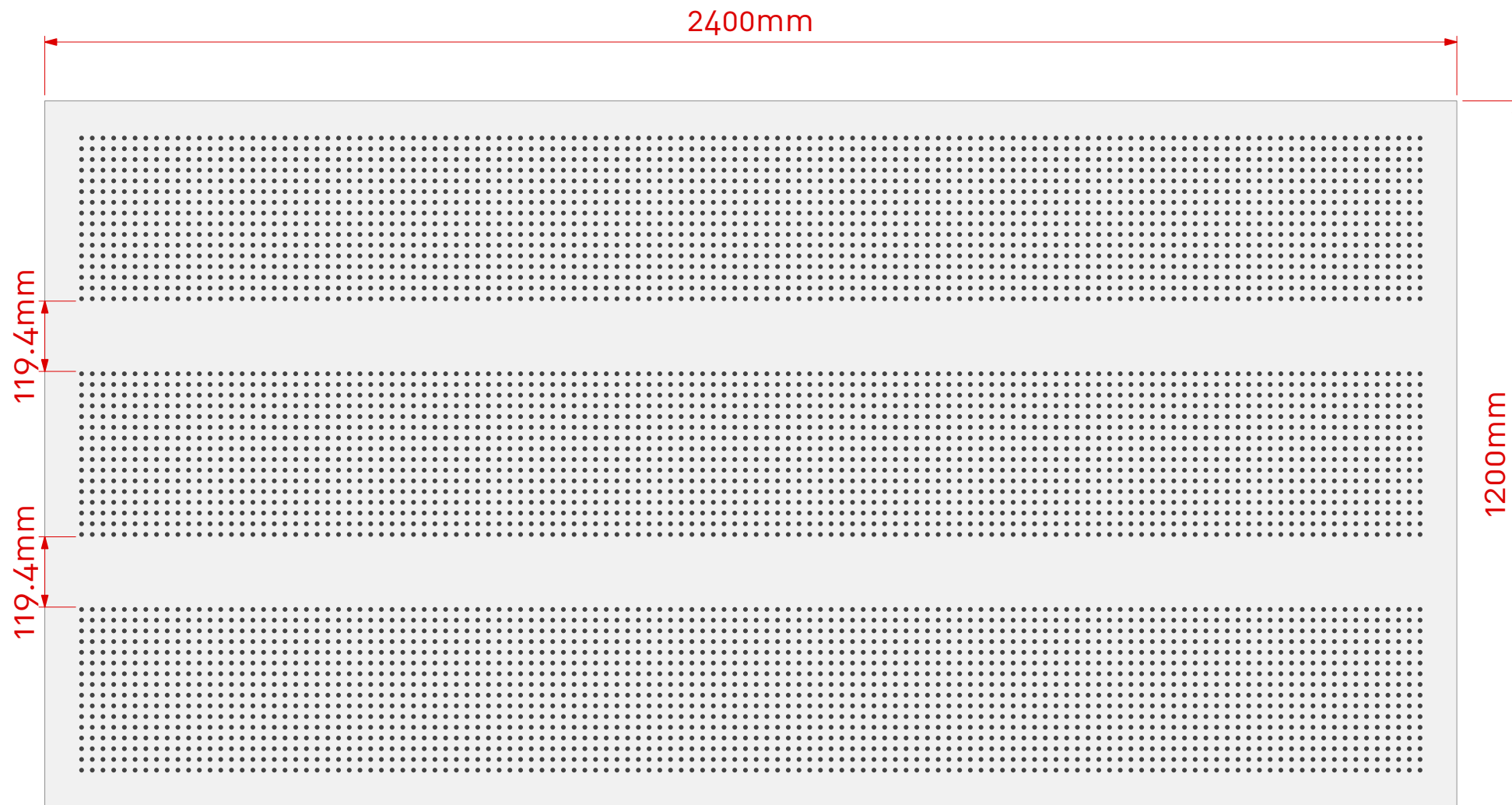

Note: Panel size, border and non perforated areas can be varied to suit project, consult Asona

Scale 1:10 @ A3

Cluster Group



www.asona.co.nz

info@asona.co.nz

6 Mahunga Drive, Mangere Bridge
Auckland 2022, New Zealand
Tel: +64 9 525 6575

Ultratone Perforated GIB® Plasterboard

Product:	Ultratone GIB®
Customer:	
Project Name:	
Job Number:	TBC

APPROVED
Date: / /
Name:
Sign:

NOTES

View: Face View

Drawing Number:	UL13.1224.8/18.W3L1
Drawing Date:	10/10/24
Drawn:	SL
Scale:	1:10 & 1:1

Ultratone™ Perforated GIB® Plasterboard

Item:	UL13.1224.12/25.W1L1
Perforations:	12mm hole @ 25mm centres
Sheet Size:	2400mm (L) x 1200mm (W)
Border:	56.5mm (L) & 56.5mm (W)
Open Area*:	15.90%

*Includes non perforated border.

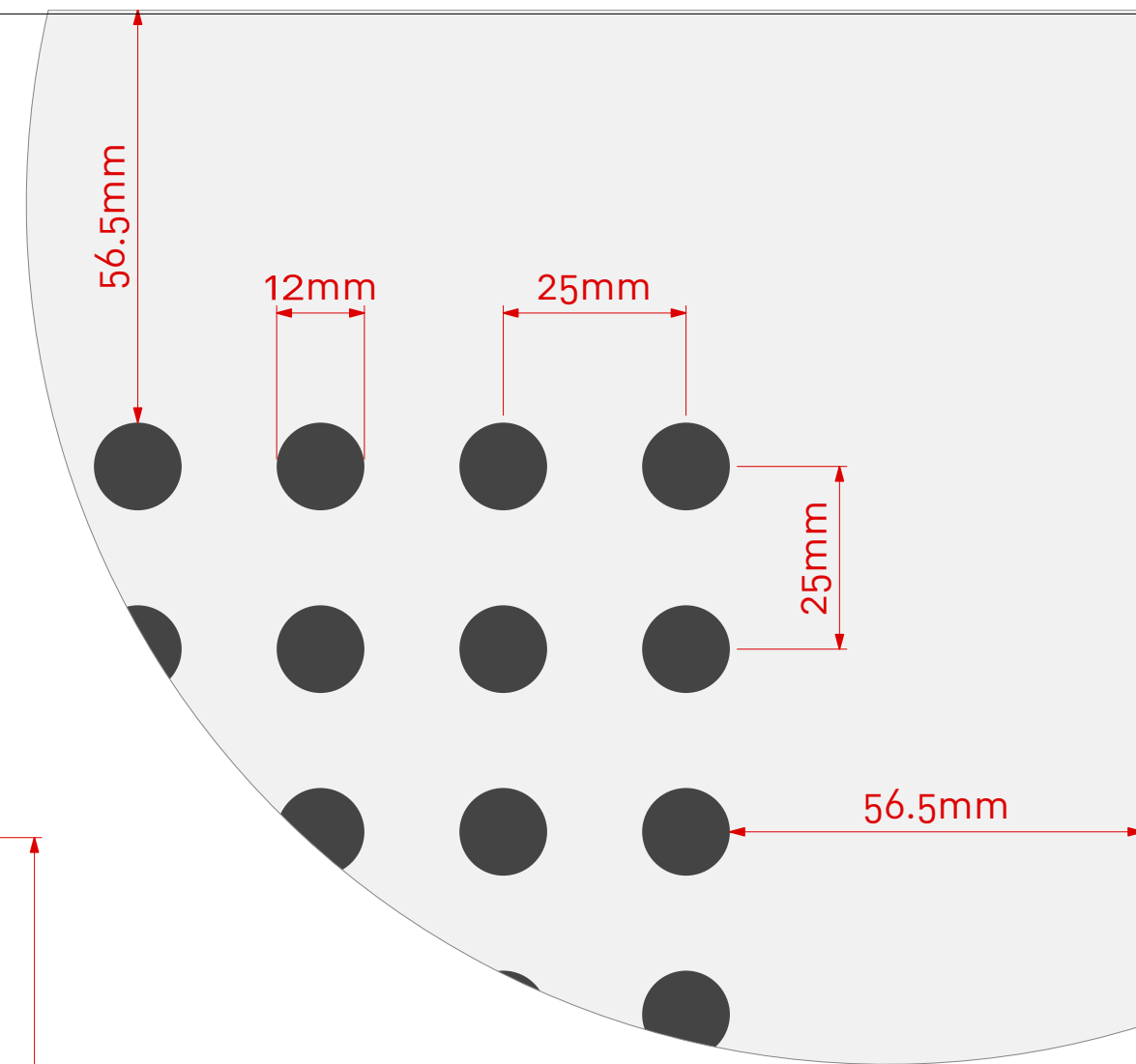
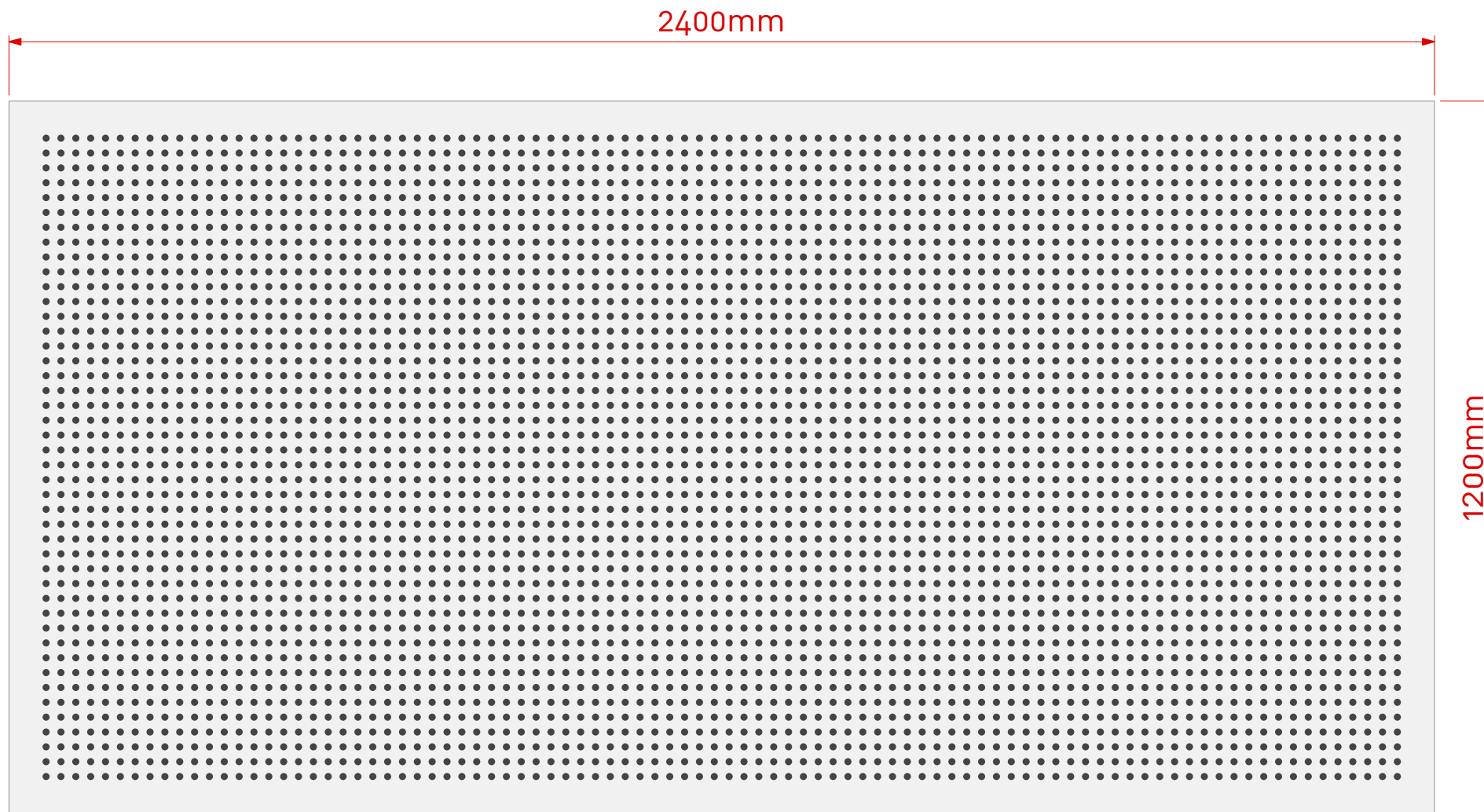

Note: Panel size, border and non perforated areas can be varied to suit project, consult Asona

Scale 1:10 @ A3

Cluster Group

asona

www.asona.co.nz

info@asona.co.nz

6 Mahunga Drive, Mangere Bridge
Auckland 2022, New Zealand
Tel: +64 9 525 6575

Ultratone Perforated GIB® Plasterboard

Product:	Ultratone GIB®
Customer:	
Project Name:	
Job Number:	TBC

APPROVED
Date: / /
Name:
Sign:

NOTES

View: Face View

Drawing Number:	UL13.1224.12/25.W1L1
Drawing Date:	10/10/24
Drawn:	SL
Scale:	1:10 & 1:1

Ultratone™ Perforated GIB® Plasterboard

Item:	UL13.1224.12/25.W1L2
Perforations:	12mm hole @ 25mm centres
Sheet Size:	2400mm (L) x 1200mm (W)
Border:	56.5mm (L) & 56.5mm (W)
Open Area*:	15.21%

*Includes non perforated border.

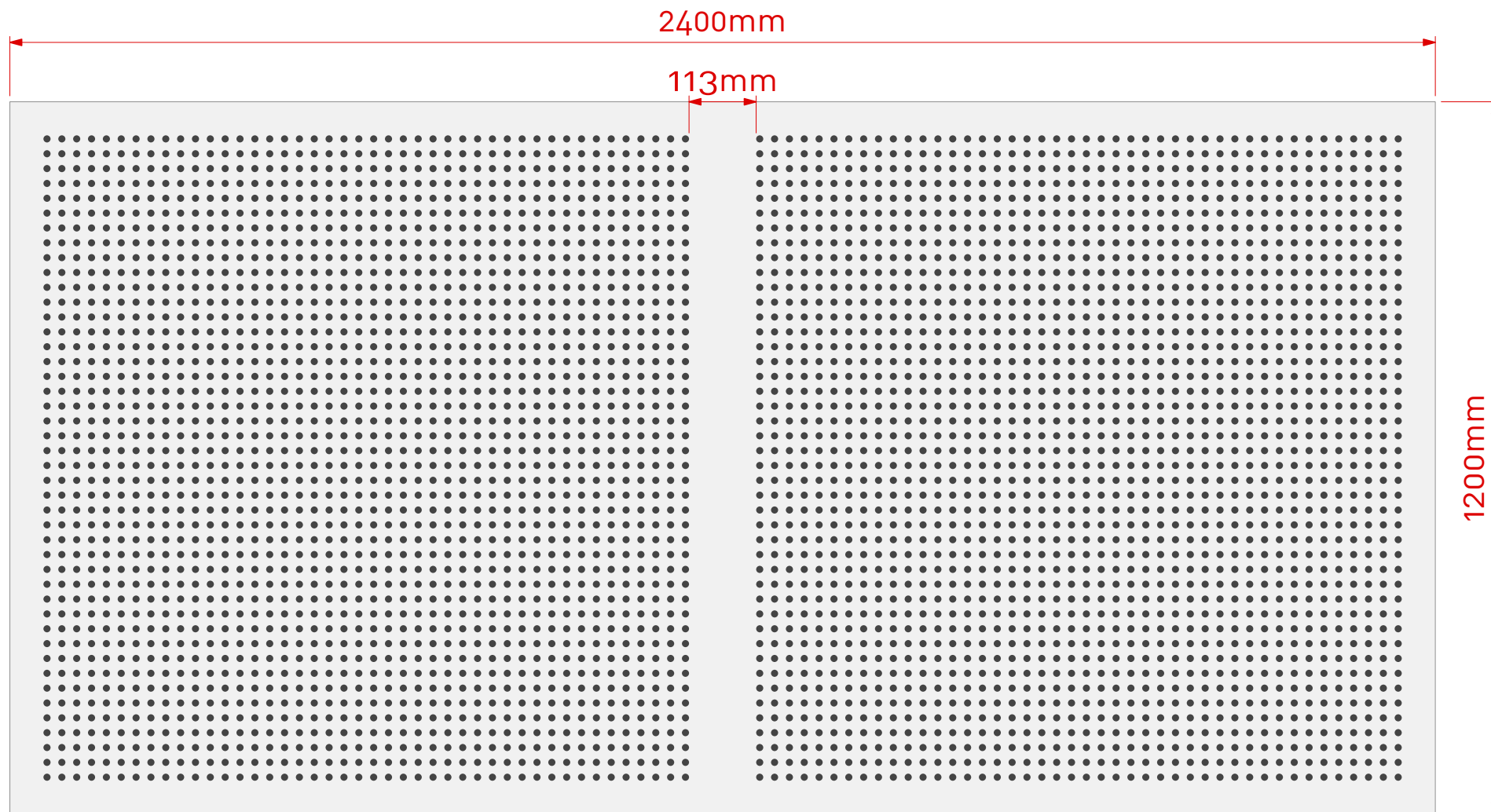

Note: Panel size, border and non perforated areas can be varied to suit project, consult Asona

Scale 1:10 @ A3

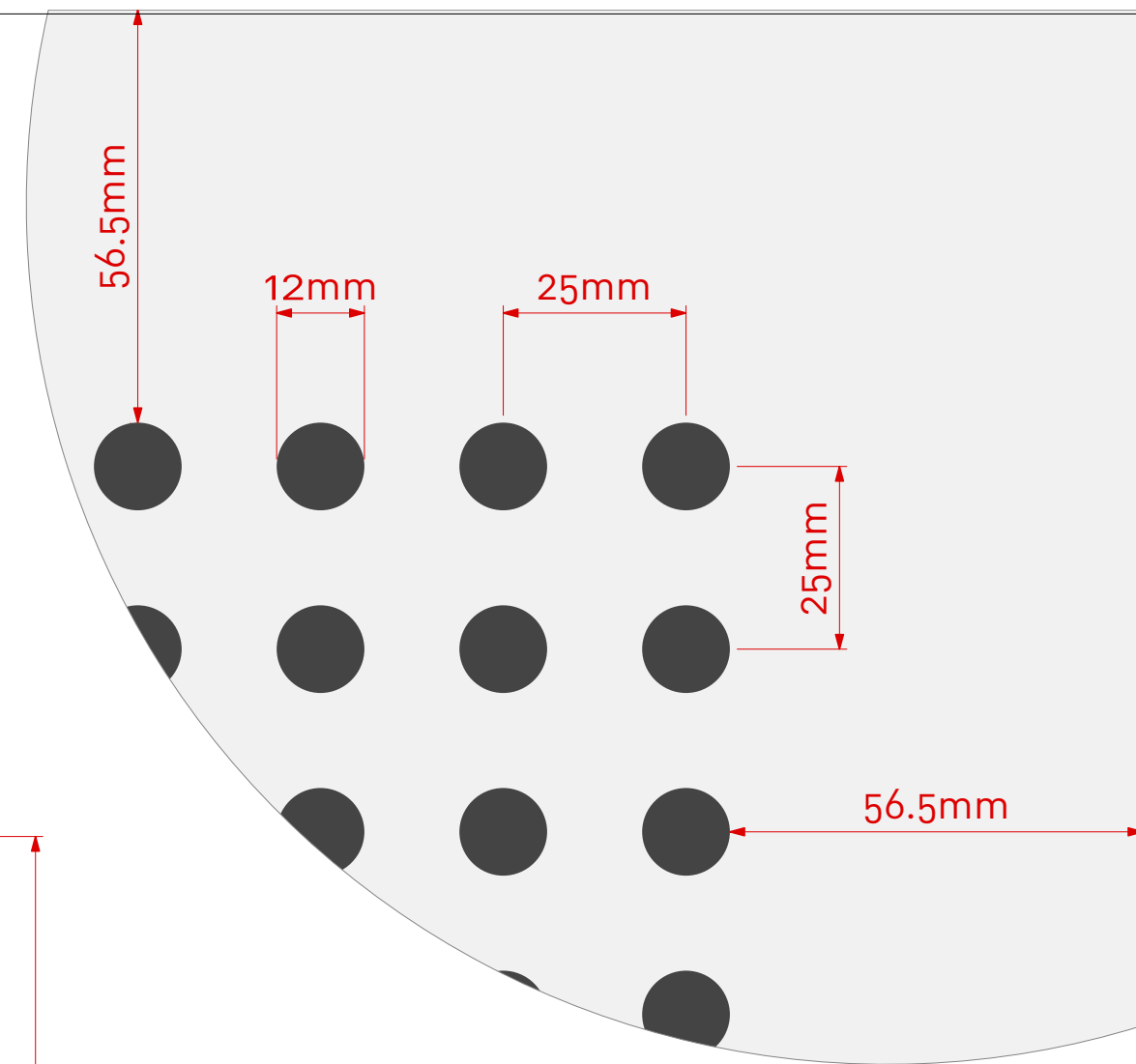

Scale 1:1 @ A3



Cluster Group



www.asona.co.nz

info@asona.co.nz

6 Mahunga Drive, Mangere Bridge
Auckland 2022, New Zealand
Tel: +64 9 525 6575

Ultratone Perforated GIB® Plasterboard

Product: Ultratone GIB®

Customer:

Project Name:

Job Number: TBC

APPROVED

Date: / /

Name:

Sign:

NOTES

View: Face View

Drawing Number: UL13.1224.12/25.W1L2

Drawing Date: 10/10/24

Drawn: SL

Scale: 1:10 & 1:1

Ultratone™ Perforated GIB® Plasterboard

Item:	UL13.1224.12/25.W2L1
Perforations:	12mm hole @ 25mm centres
Sheet Size:	2400mm (L) x 1200mm (W)
Border:	56.5mm (L) & 56.5mm (W)
Open Area*:	14.45%

*Includes non perforated border.

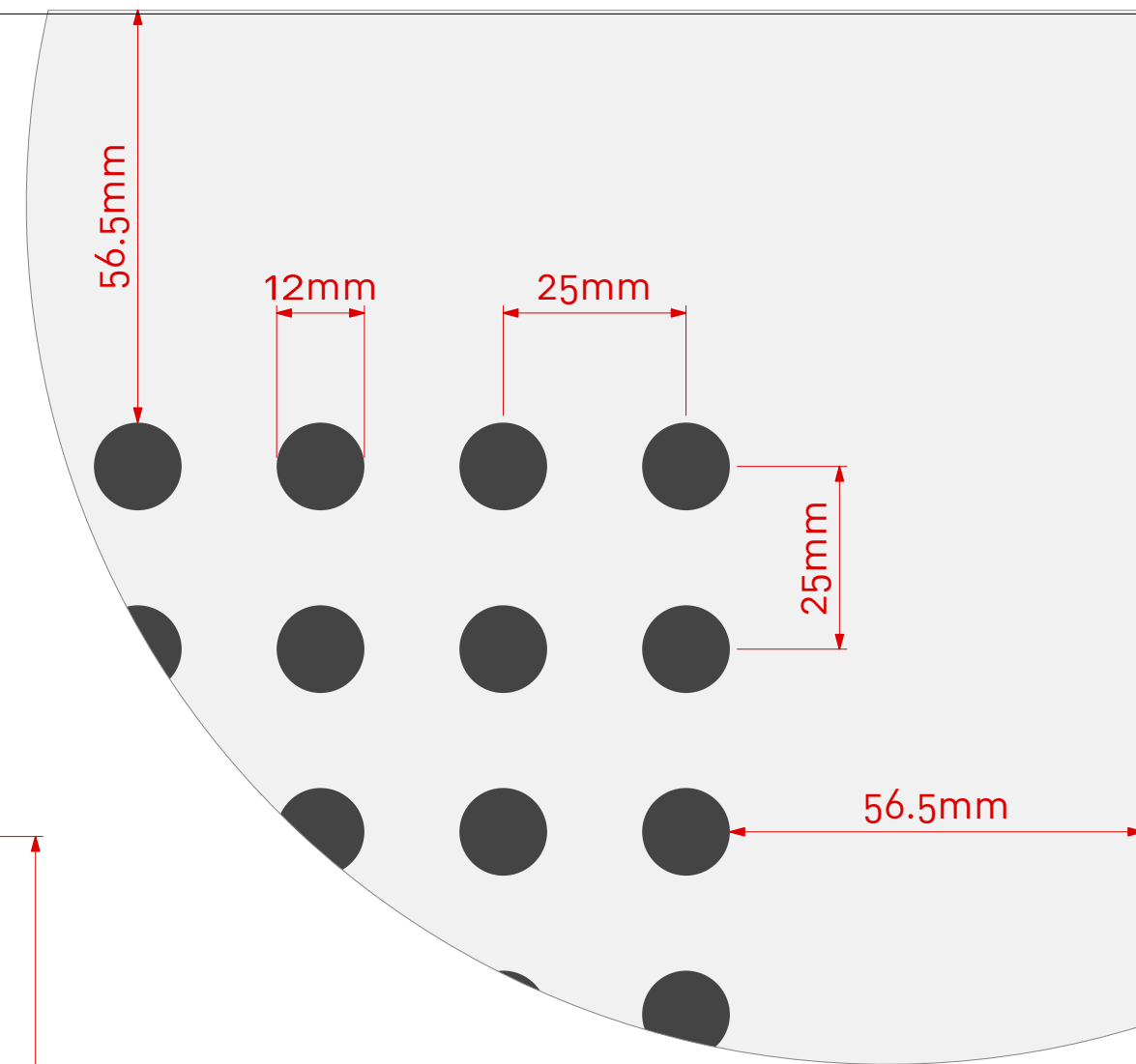
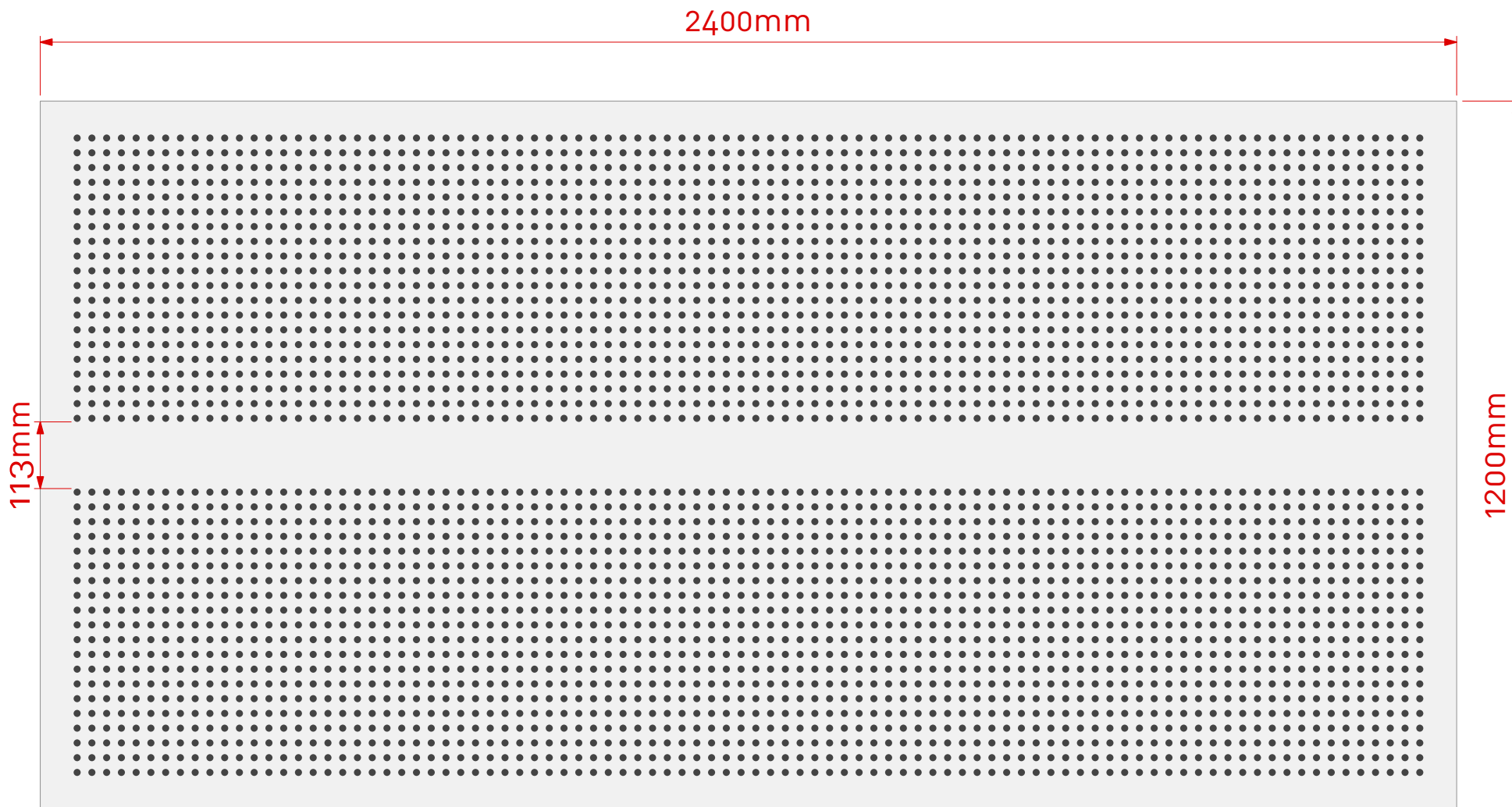

Note: Panel size, border and non perforated areas can be varied to suit project, consult Asona

Scale 1:10 @ A3



www.asona.co.nz

info@asona.co.nz

6 Mahunga Drive, Mangere Bridge
Auckland 2022, New Zealand
Tel: +64 9 525 6575

Ultratone Perforated GIB® Plasterboard

Product: Ultratone GIB®

Customer:

Project Name:

Job Number: TBC

APPROVED

Date: / /

Name:

Sign:

NOTES

View: Face View

Drawing Number: UL13.1224.12/25.W2L1

Drawing Date: 10/10/24

Drawn: SL

Scale: 1:10 & 1:1

Ultratone™ Perforated GIB® Plasterboard

Item:	UL13.1224.12/25.W2L2
Perforations:	12mm hole @ 25mm centres
Sheet Size:	2400mm (L) x 1200mm (W)
Border:	56.5mm (L) & 56.5mm (W)
Open Area*:	13.82%

*Includes non perforated border.

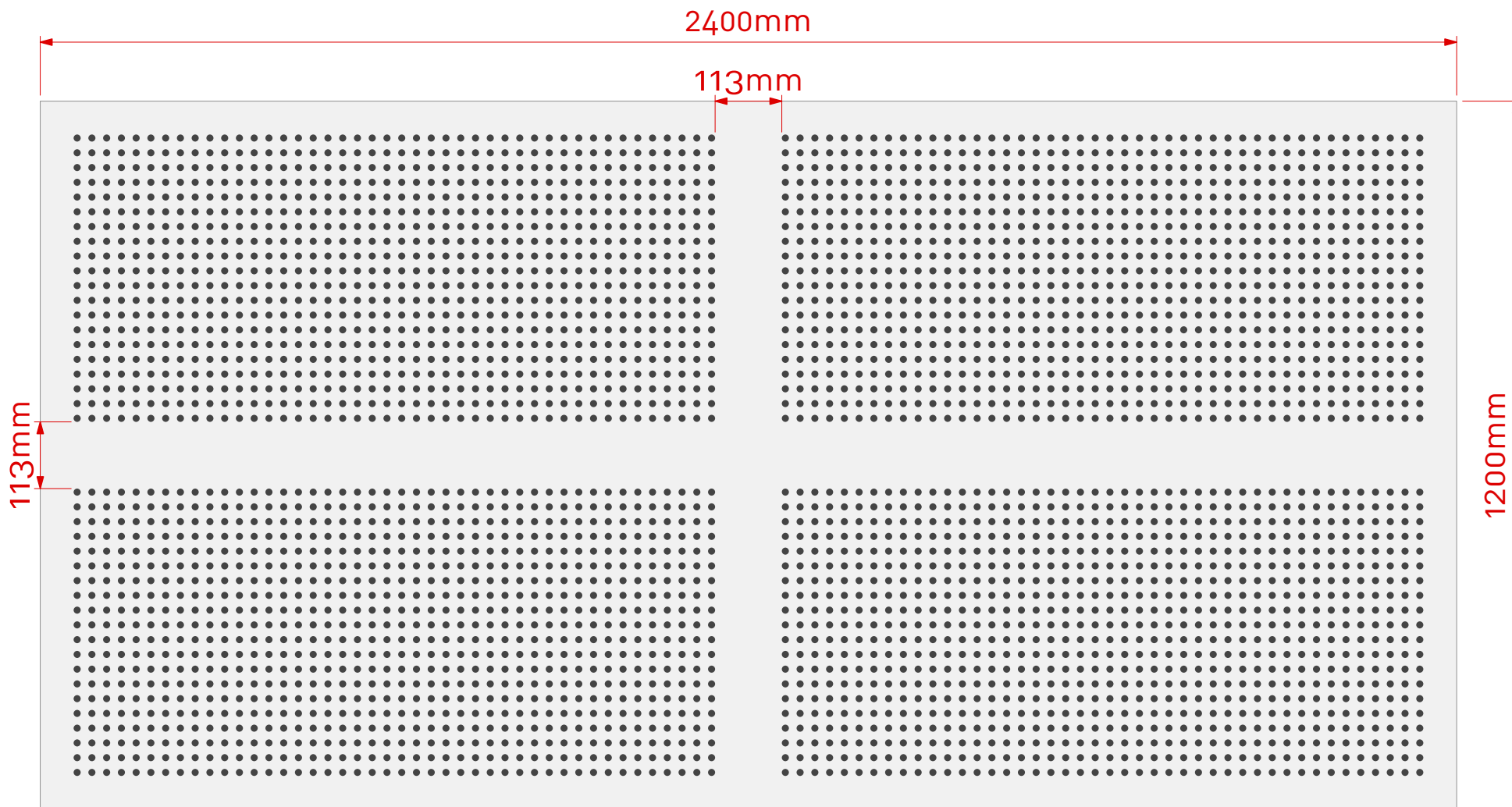

Note: Panel size, border and non perforated areas can be varied to suit project, consult Asona

Scale 1:10 @ A3

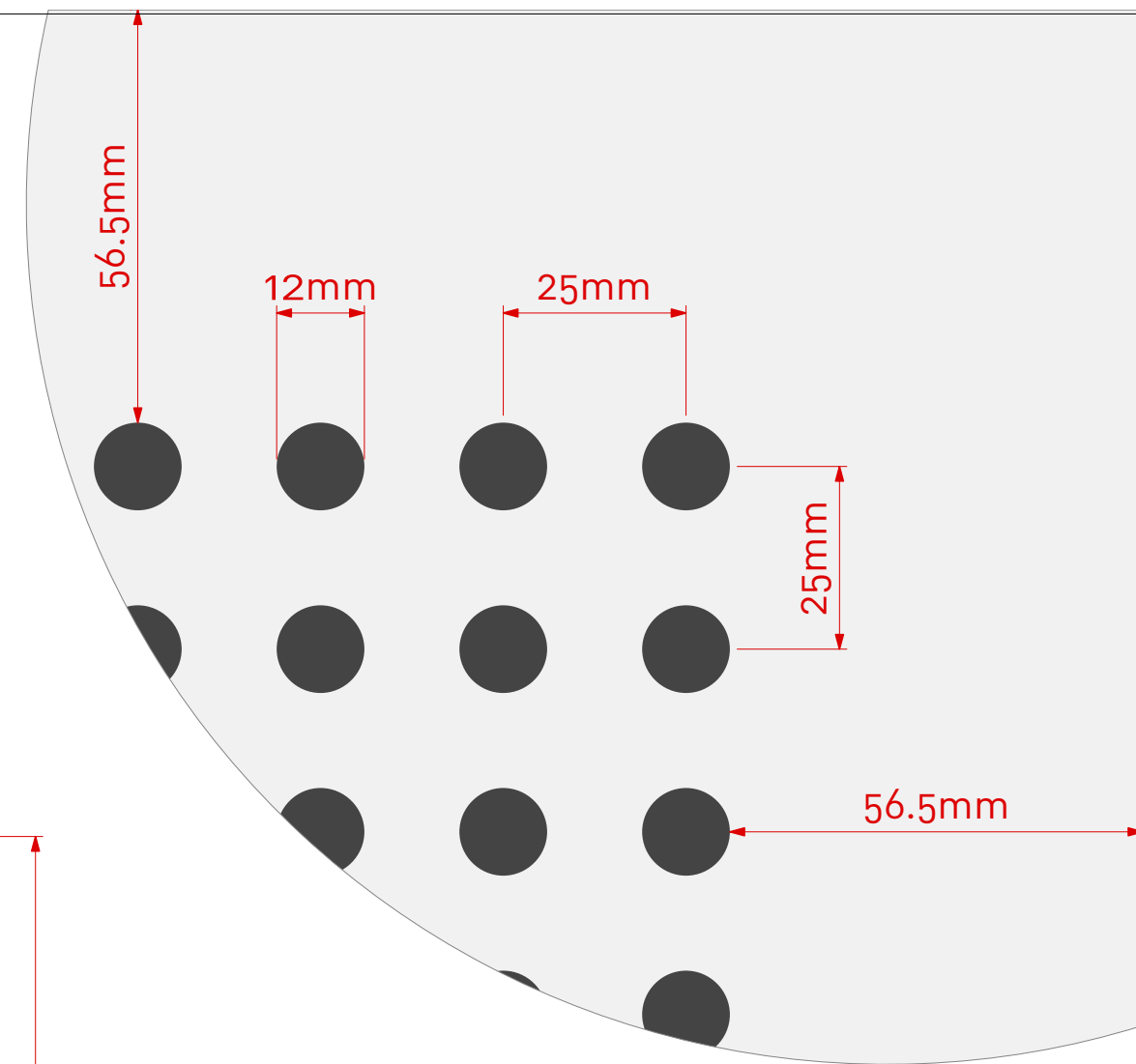

Scale 1:1 @ A3

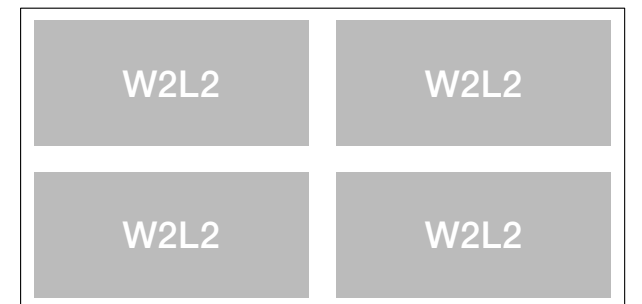

Cluster Group



www.asona.co.nz

info@asona.co.nz

6 Mahunga Drive, Mangere Bridge
Auckland 2022, New Zealand
Tel: +64 9 525 6575

Ultratone Perforated GIB® Plasterboard

Product:	Ultratone GIB®
Customer:	
Project Name:	
Job Number:	TBC

APPROVED
Date: / /
Name:
Sign:

NOTES

View: Face View

Drawing Number:	UL13.1224.12/25.W2L2
Drawing Date:	10/10/24
Drawn:	SL
Scale:	1:10 & 1:1

Ultratone™ Perforated GIB® Plasterboard

Item:	UL13.1224.12/25.W2L4
Perforations:	12mm hole @ 25mm centres
Sheet Size:	2400mm (L) x 1200mm (W)
Border:	56.5mm (L) & 56.5mm (W)
Open Area*:	12.57%

*Includes non perforated border.

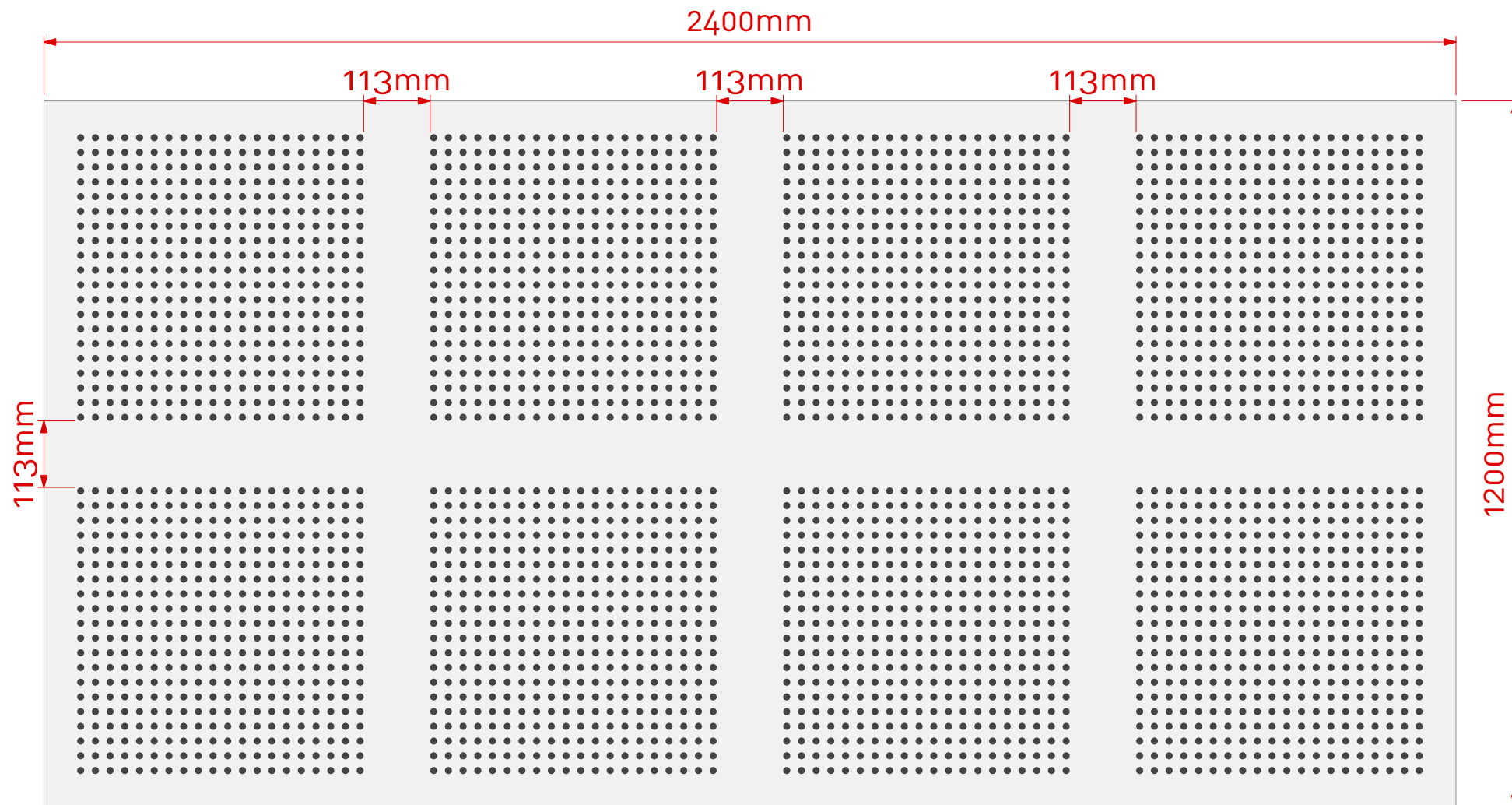

Note: Panel size, border and non perforated areas can be varied to suit project, consult Asona

Scale 1:10 @ A3

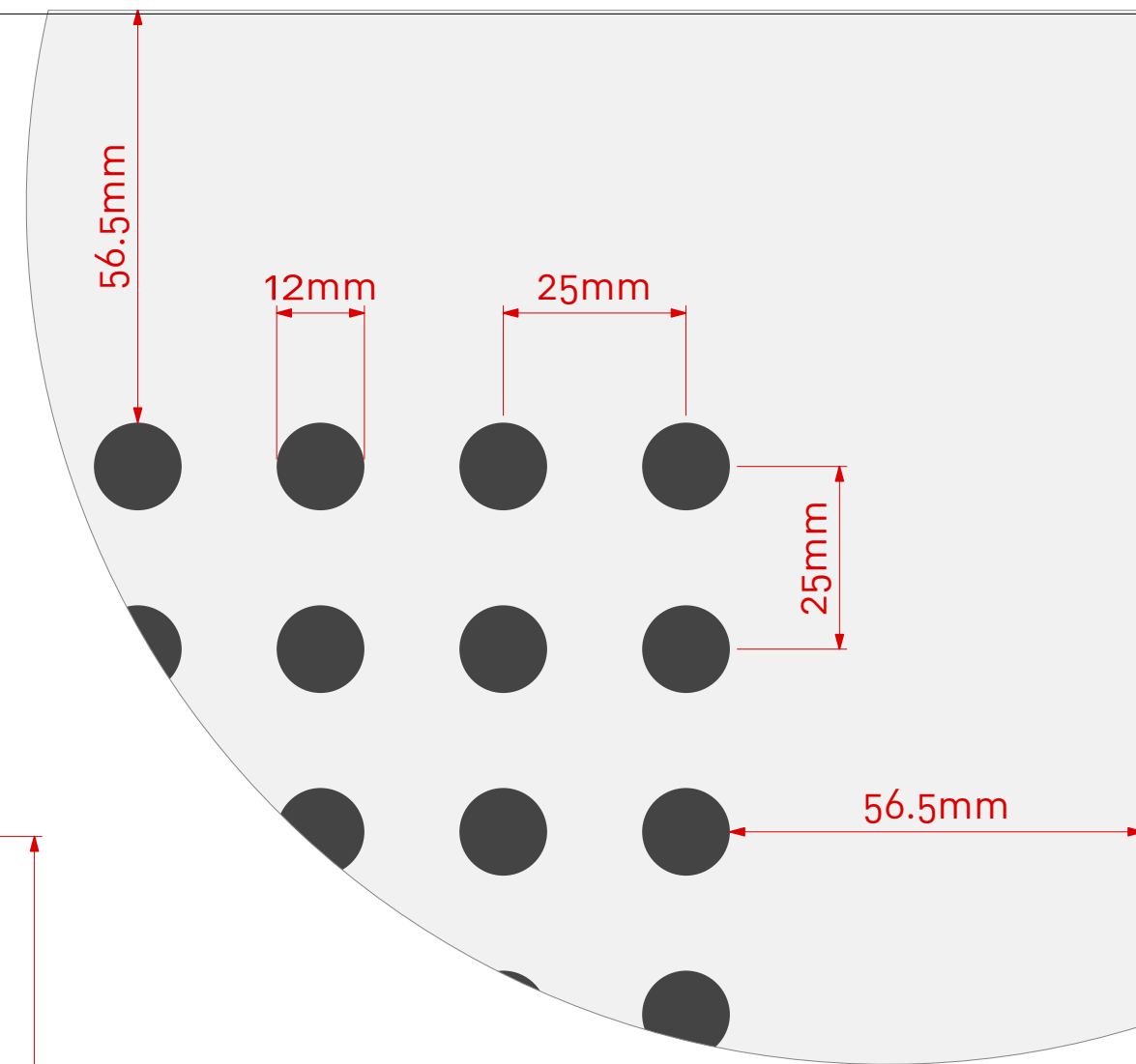

Scale 1:1 @ A3



Cluster Group



www.asona.co.nz

info@asona.co.nz

6 Mahunga Drive, Mangere Bridge
Auckland 2022, New Zealand
Tel: +64 9 525 6575

Ultratone Perforated GIB® Plasterboard

Product:	Ultratone GIB®
Customer:	
Project Name:	
Job Number:	TBC

APPROVED
Date: / /
Name:
Sign:

NOTES

View: Face View

Drawing Number:	UL13.1224.12/25.W2L4
Drawing Date:	10/10/24
Drawn:	SL
Scale:	1:10 & 1:1

Ultratone™ Perforated GIB® Plasterboard

Item:	UL13.1224.12/25.W3L1
Perforations:	12mm hole @ 25mm centres
Sheet Size:	2400mm (L) x 1200mm (W)
Border:	56.5mm (L) & 56.5mm (W)
Open Area*:	13.01%

*Includes non perforated border.

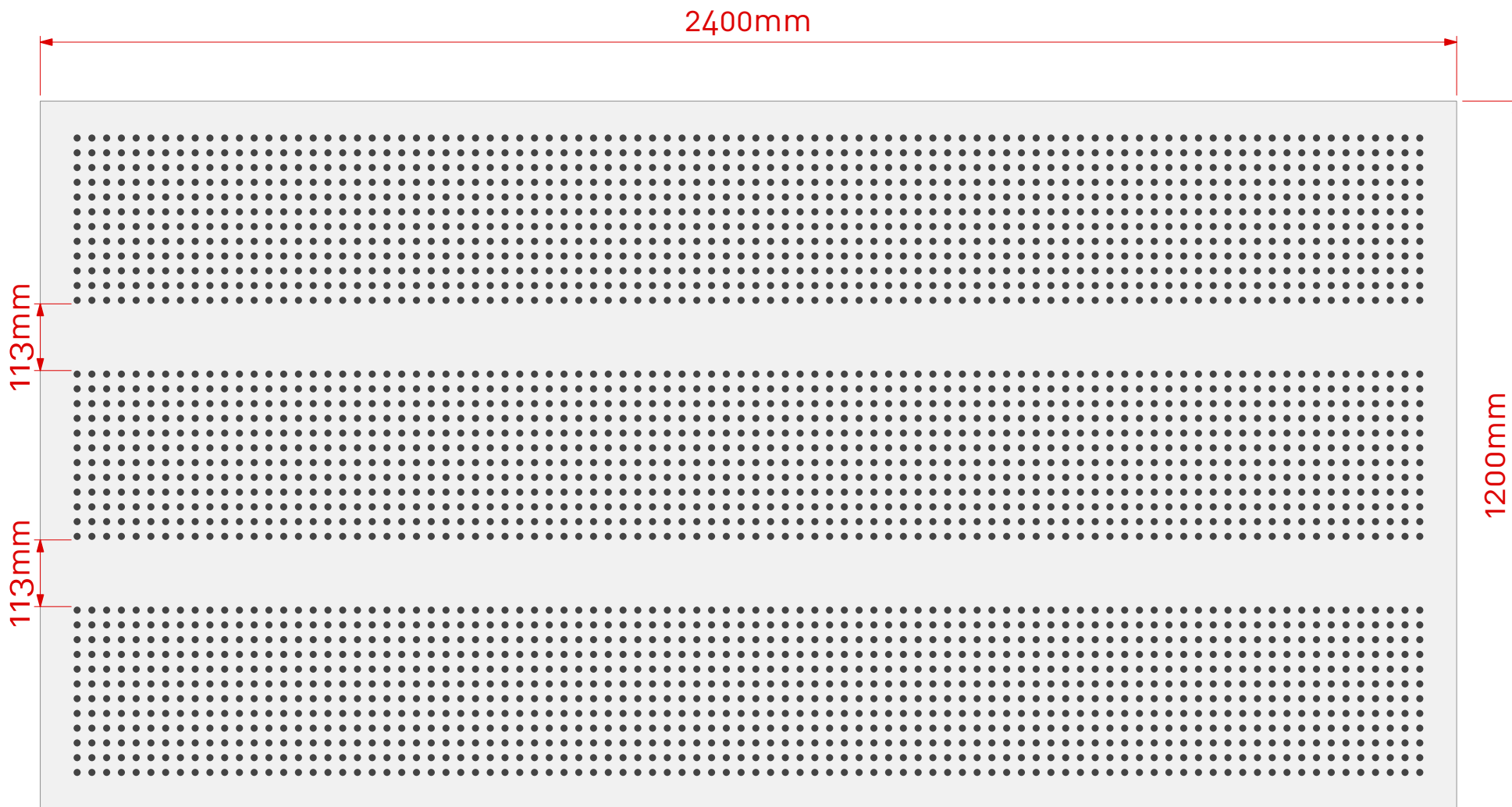

Note: Panel size, border and non perforated areas can be varied to suit project, consult Asona

Scale 1:10 @ A3

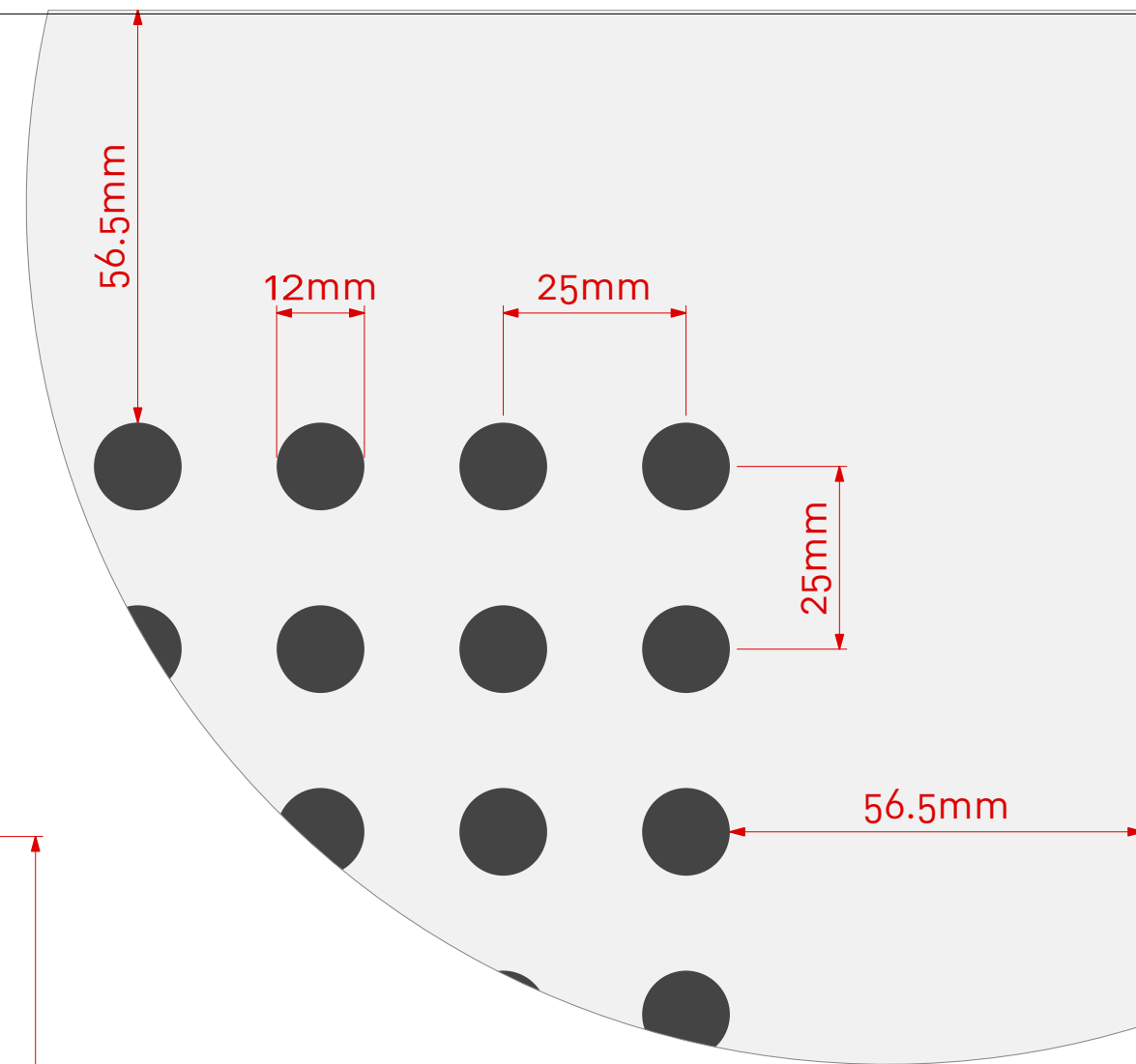

Scale 1:1 @ A3

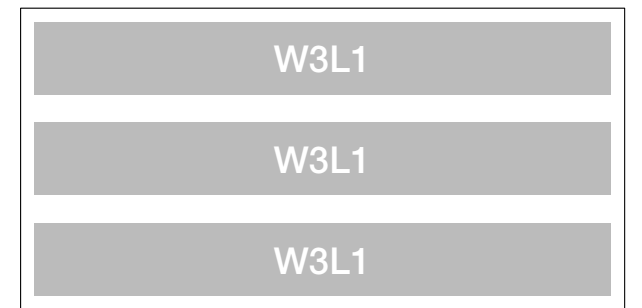

Cluster Group

asona

www.asona.co.nz

info@asona.co.nz

6 Mahunga Drive, Mangere Bridge
Auckland 2022, New Zealand
Tel: +64 9 525 6575

Ultratone Perforated GIB® Plasterboard

Product:	Ultratone GIB®
Customer:	
Project Name:	
Job Number:	TBC

APPROVED
Date: / /
Name:
Sign:

NOTES

View: Face View

Drawing Number:	UL13.1224.12/25.W3L1
Drawing Date:	10/10/24
Drawn:	SL
Scale:	1:10 & 1:1

Ultratone™ Perforated GIB® Plasterboard

Item:	UL13.1224.15/30.W1L1
Perforations:	15mm hole @ 30mm centres
Sheet Size:	2400mm (L) x 1200mm (W)
Border:	67.5mm (L) & 67.5mm (W)
Open Area*:	16.79%

*Includes non perforated border.

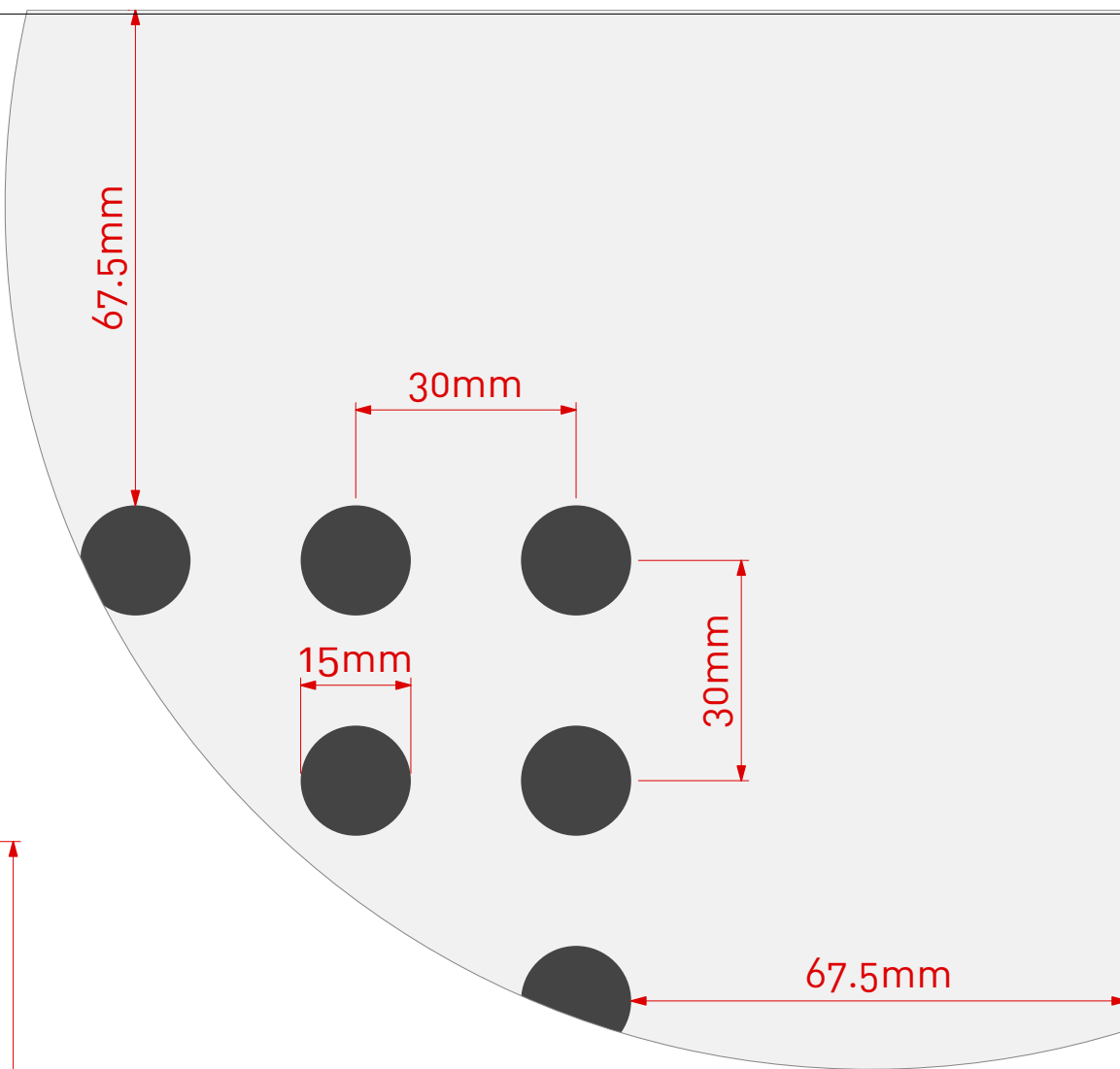
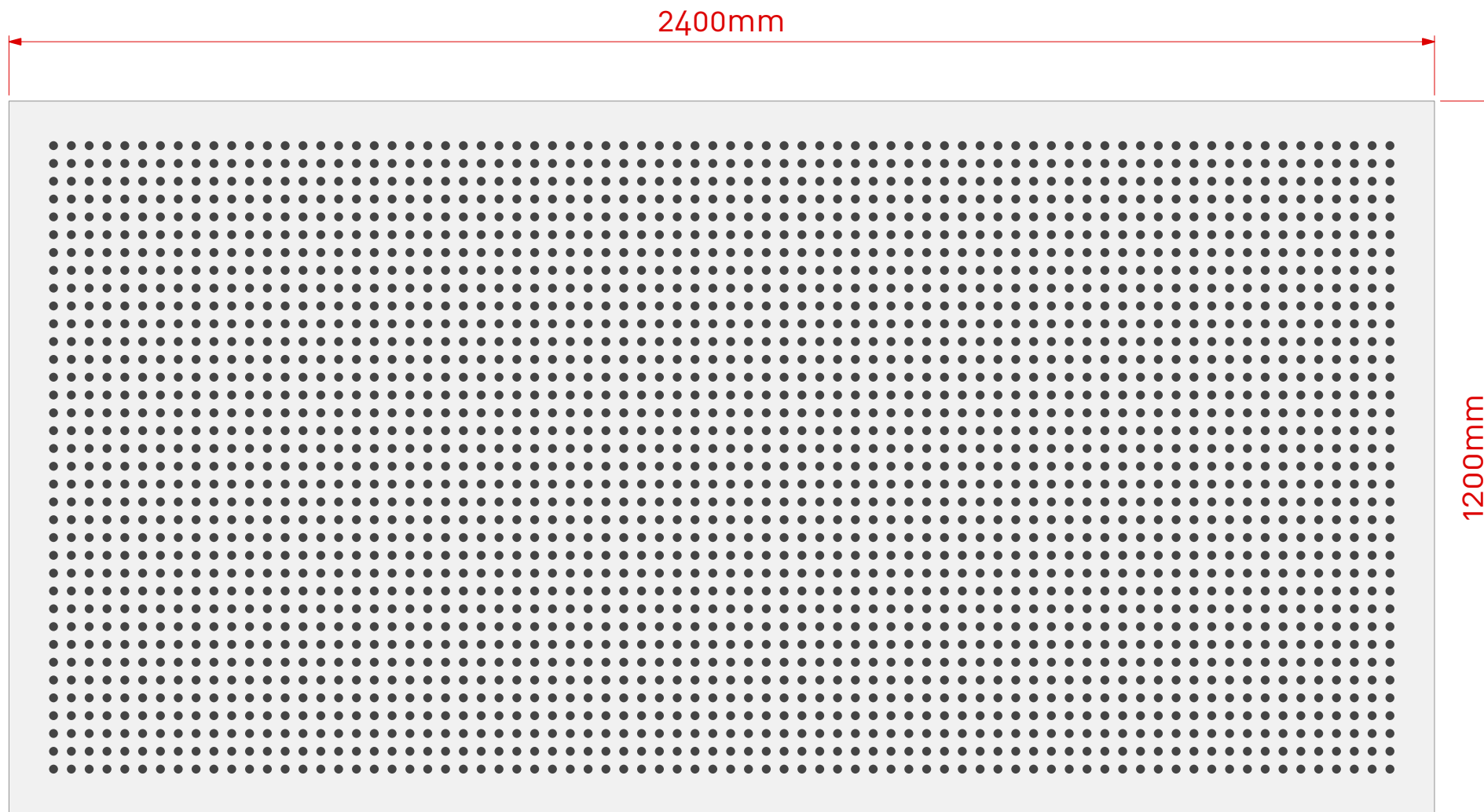

Note: Panel size, border and non perforated areas can be varied to suit project, consult Asona

Scale 1:10 @ A3

Cluster Group

asona

www.asona.co.nz

info@asona.co.nz

6 Mahunga Drive, Mangere Bridge
Auckland 2022, New Zealand
Tel: +64 9 525 6575

Ultratone Perforated GIB® Plasterboard

Product: Ultratone GIB®

Customer:

Project Name:

Job Number: TBC

APPROVED

Date: / /

Name:

Sign:

NOTES

View: Face View

Drawing Number: UL13.1224.15/30.W1L1

Drawing Date: 10/10/24

Drawn: SL

Scale: 1:10 & 1:1

Ultratone™ Perforated GIB® Plasterboard

Item:	UL13.1224.15/30.W1L2
Perforations:	15mm hole @ 30mm centres
Sheet Size:	2400mm (L) x 1200mm (W)
Border:	67.5mm (L) & 67.5mm (W)
Open Area*:	15.90%

*Includes non perforated border.

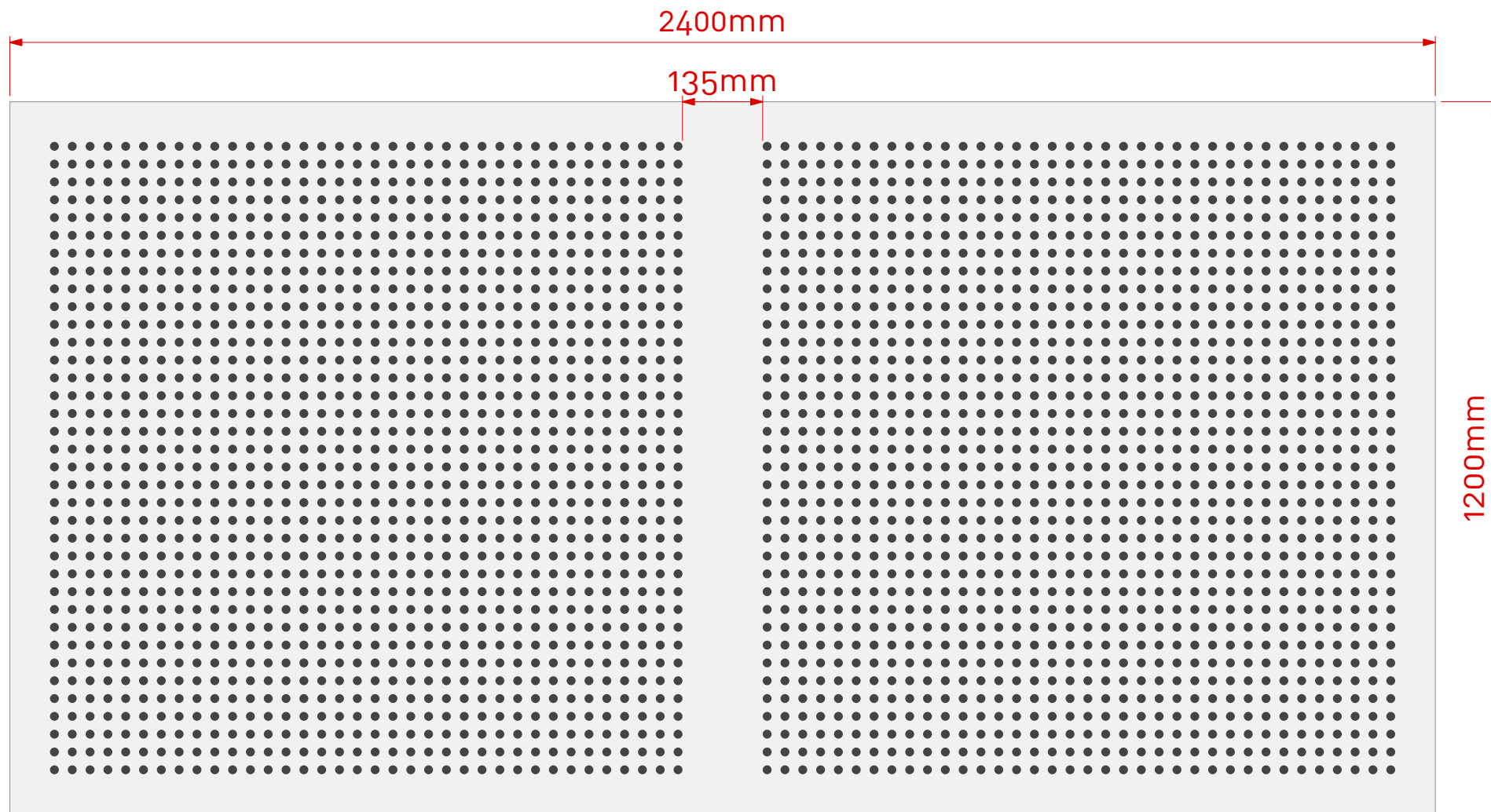

Note: Panel size, border and non perforated areas can be varied to suit project, consult Asona

Scale 1:10 @ A3

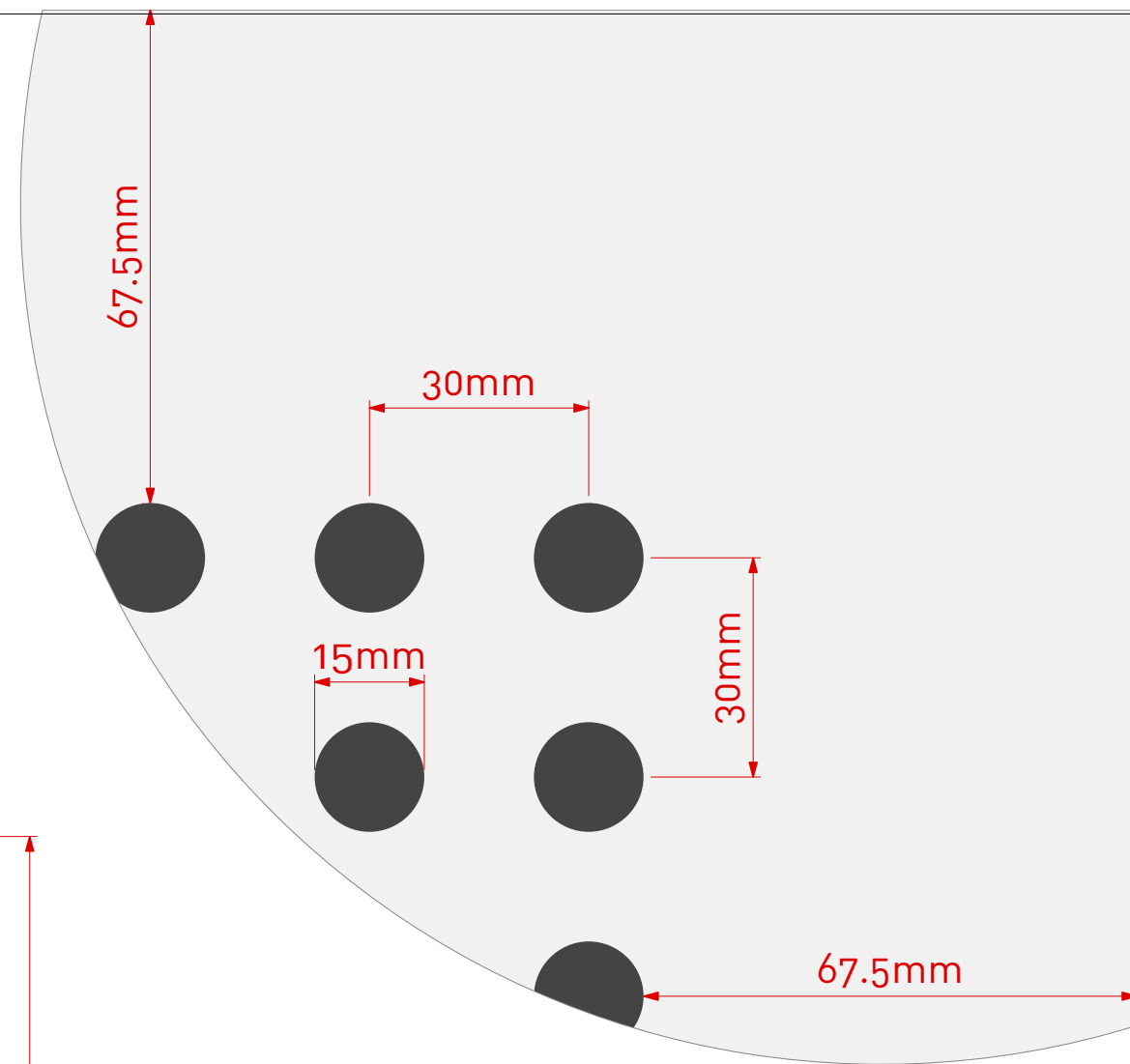

Scale 1:1 @ A3



Cluster Group

asona

www.asona.co.nz

info@asona.co.nz

6 Mahunga Drive, Mangere Bridge
Auckland 2022, New Zealand
Tel: +64 9 525 6575

Ultratone Perforated GIB® Plasterboard

Product: Ultratone GIB®

Customer:

Project Name:

Job Number: TBC

APPROVED

Date: / /

Name:

Sign:

NOTES

View: Face View

Drawing Number: UL13.1224.15/30.W1L2

Drawing Date: 10/10/24

Drawn: SL

Scale: 1:10 & 1:1

Ultratone™ Perforated GIB® Plasterboard

Item:	UL13.1224.15/30.W2L1
Perforations:	15mm hole @ 30mm centres
Sheet Size:	2400mm (L) x 1200mm (W)
Border:	67.5mm (L) & 67.5mm (W)
Open Area*:	14.92%

*Includes non perforated border.

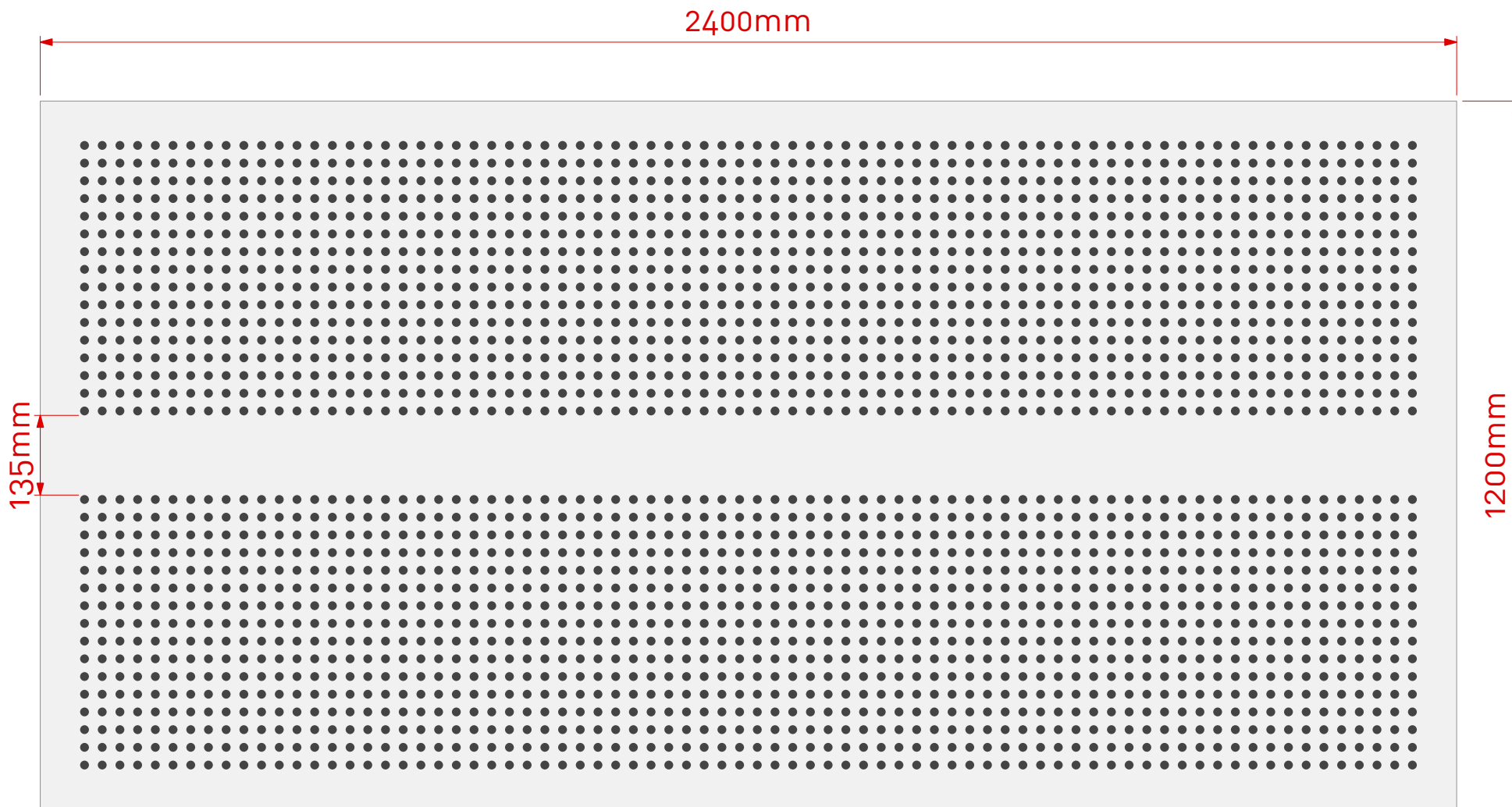

Note: Panel size, border and non perforated areas can be varied to suit project, consult Asona

Scale 1:10 @ A3

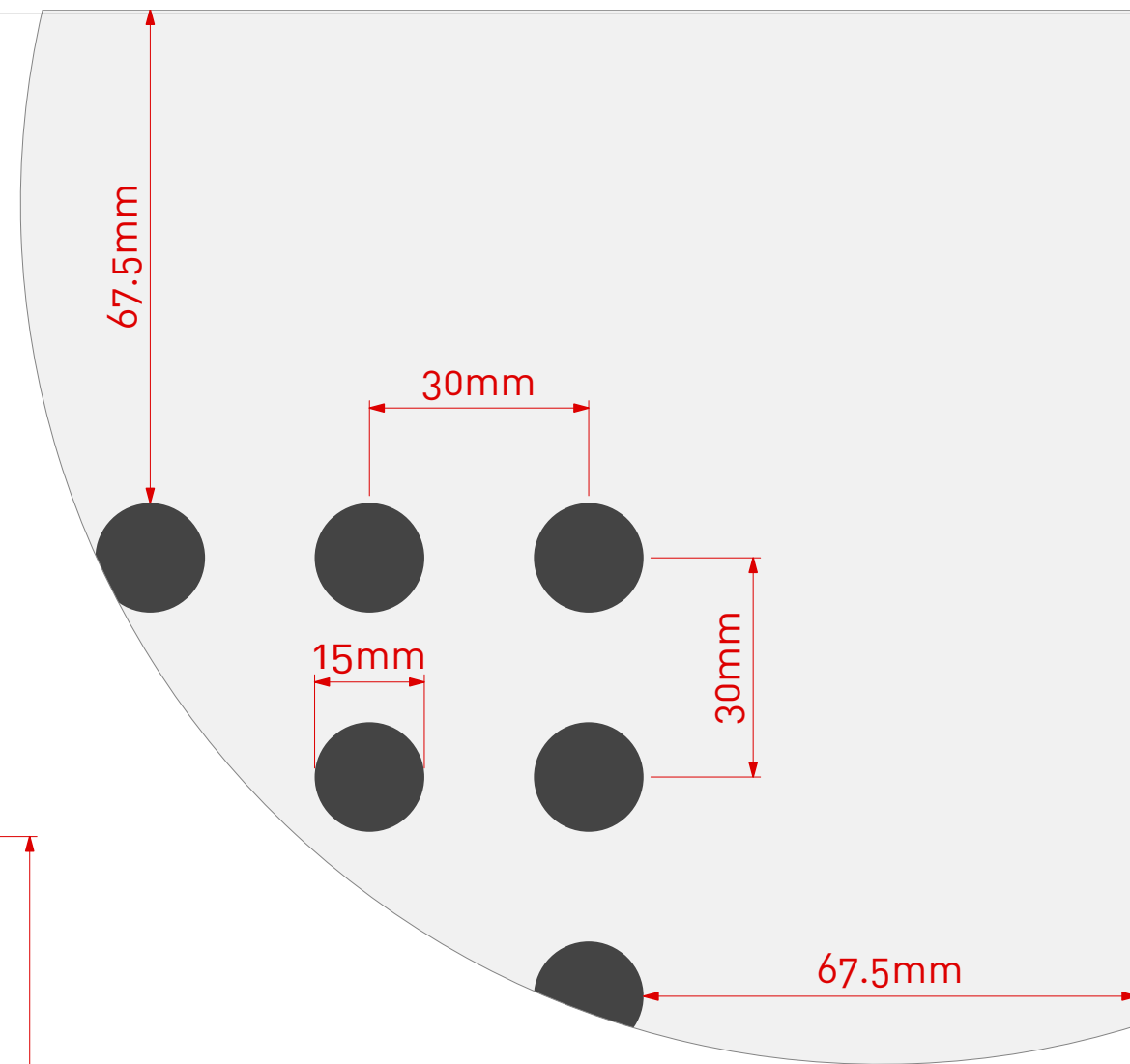

Scale 1:1 @ A3



Cluster Group



www.asona.co.nz

info@asona.co.nz

6 Mahunga Drive, Mangere Bridge
Auckland 2022, New Zealand
Tel: +64 9 525 6575

Ultratone Perforated GIB® Plasterboard

Product: Ultratone GIB®

Customer:

Project Name:

Job Number: TBC

APPROVED

Date: / /

Name:

Sign:

NOTES

View: Face View

Drawing Number: UL13.1224.15/30.W2L1

Drawing Date: 10/10/24

Drawn: SL

Scale: 1:10 & 1:1

Ultratone™ Perforated GIB® Plasterboard

Item:	UL13.1224.15/30.W2L2
Perforations:	15mm hole @ 30mm centres
Sheet Size:	2400mm (L) x 1200mm (W)
Border:	67.5mm (L) & 67.5mm (W)
Open Area*:	14.14%

*Includes non perforated border.

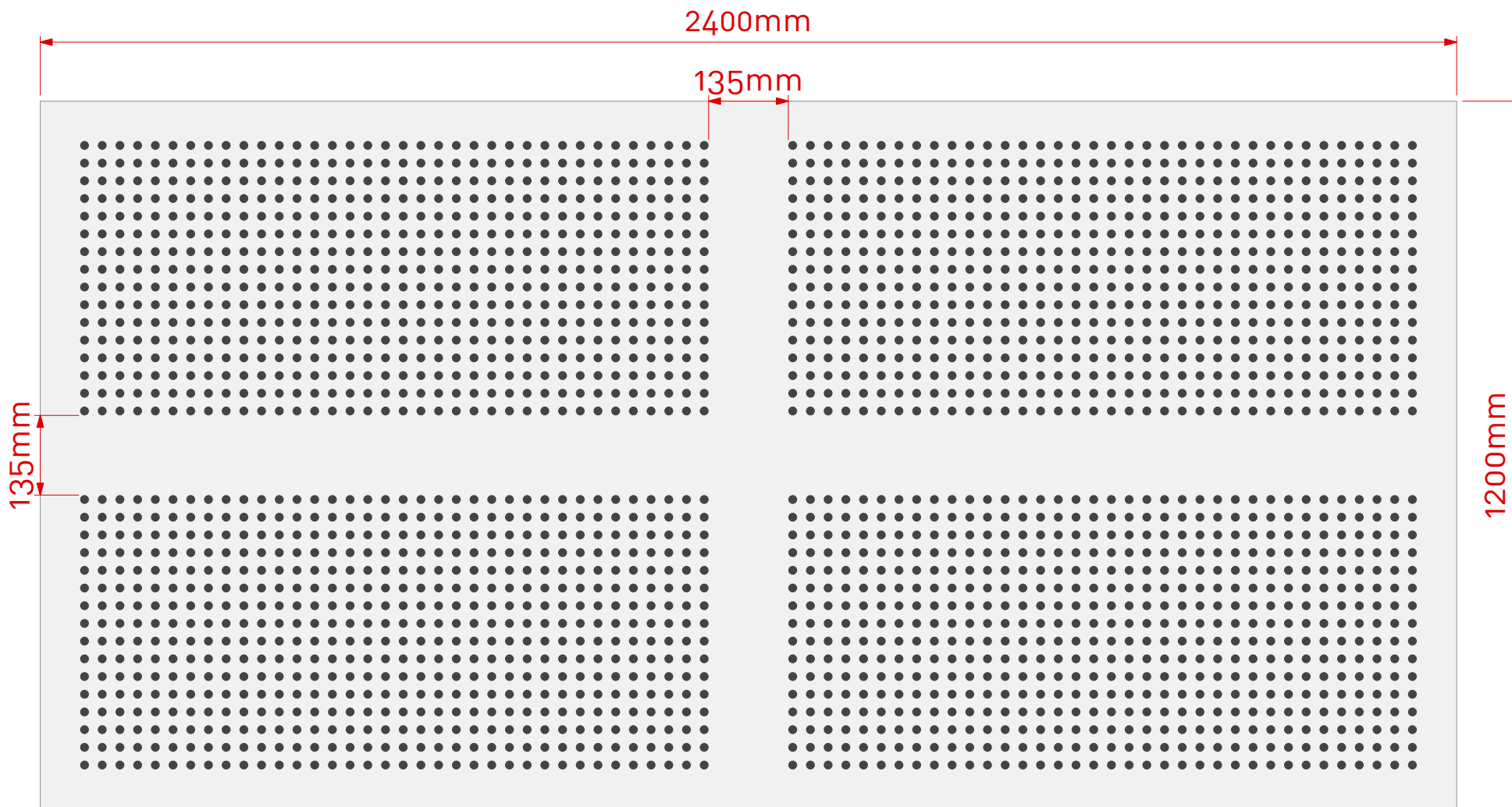

Note: Panel size, border and non perforated areas can be varied to suit project, consult Asona

Scale 1:10 @ A3

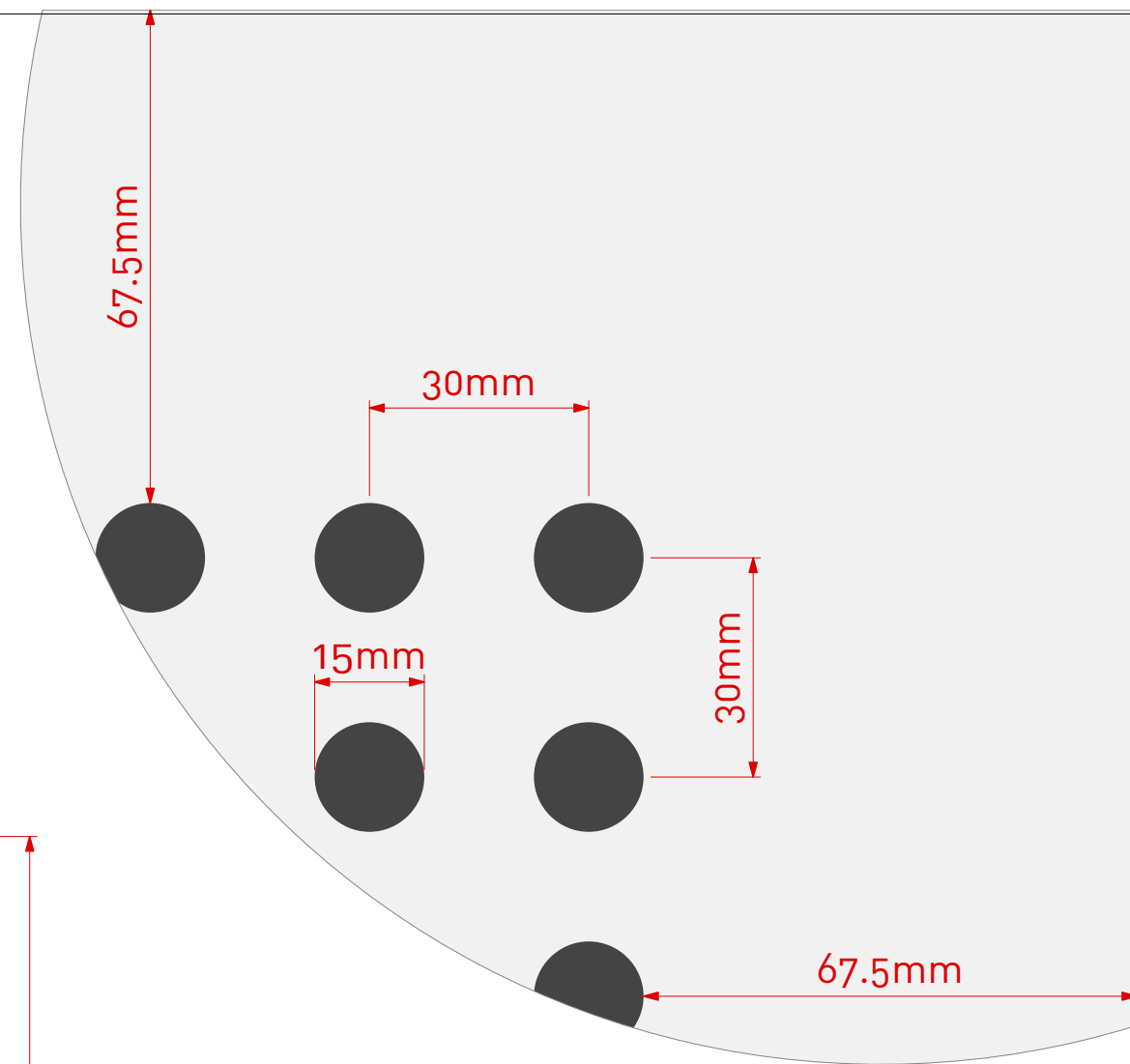

Scale 1:1 @ A3

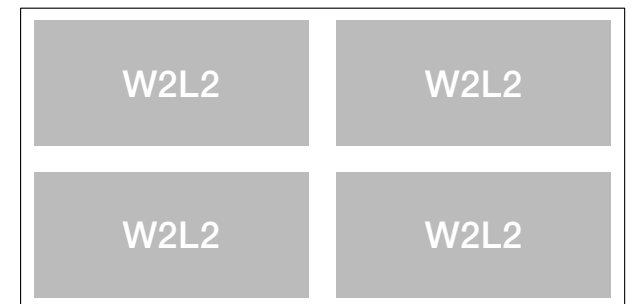

Cluster Group



www.asona.co.nz

info@asona.co.nz

6 Mahunga Drive, Mangere Bridge
Auckland 2022, New Zealand
Tel: +64 9 525 6575

Ultratone Perforated GIB® Plasterboard

Product: Ultratone GIB®

Customer:

Project Name:

Job Number: TBC

APPROVED

Date: / /

Name:

Sign:

NOTES

View: Face View

Drawing Number: UL13.1224.15/30.W2L2

Drawing Date: 10/10/24

Drawn: SL

Scale: 1:10 & 1:1

Ultratone™ Perforated GIB® Plasterboard

Item:	UL13.1224.15/30.W2L4
Perforations:	15mm hole @ 30mm centres
Sheet Size:	2400mm (L) x 1200mm (W)
Border:	67.5mm (L) & 67.5mm (W)
Open Area*:	12.57%

*Includes non perforated border.

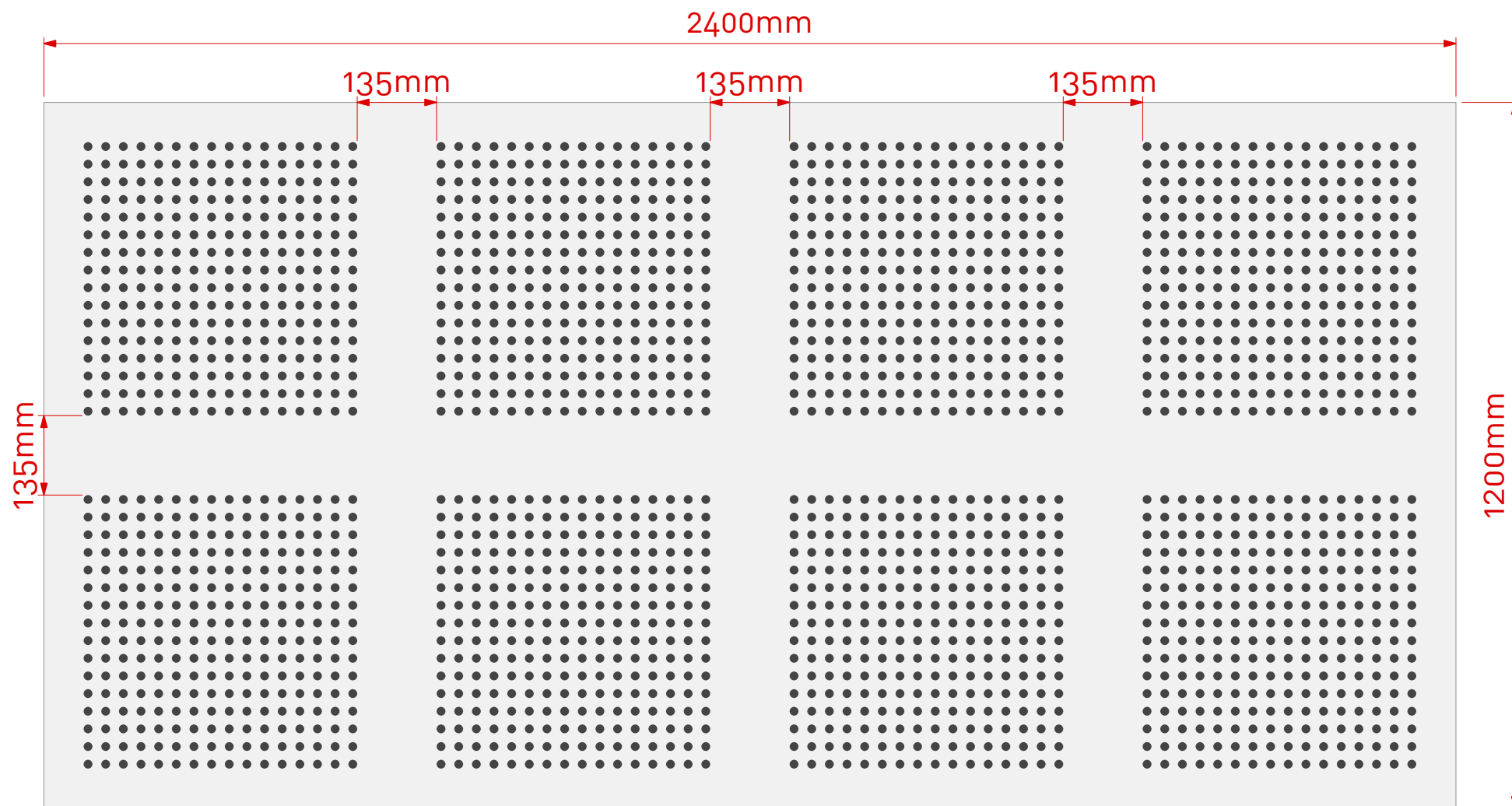

Note: Panel size, border and non perforated areas can be varied to suit project, consult Asona

Scale 1:10 @ A3

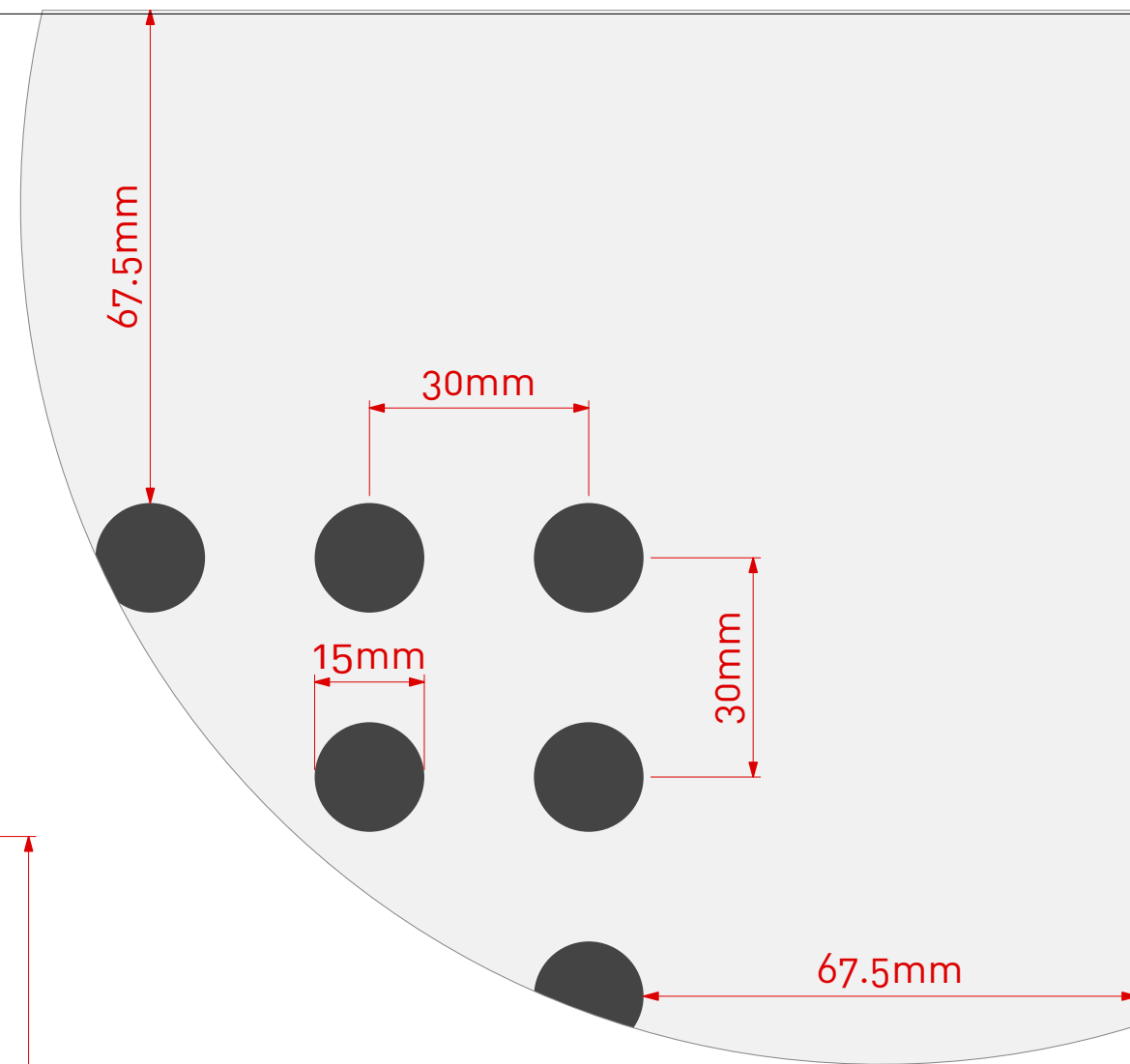

Scale 1:1 @ A3



Cluster Group

asona

www.asona.co.nz

info@asona.co.nz

6 Mahunga Drive, Mangere Bridge
Auckland 2022, New Zealand
Tel: +64 9 525 6575

Ultratone Perforated GIB® Plasterboard

Product: Ultratone GIB®

Customer:

Project Name:

Job Number: TBC

APPROVED

Date: / /

Name:

Sign:

NOTES

View: Face View

Drawing Number: UL13.1224.15/30.W2L4

Drawing Date: 10/10/24

Drawn: SL

Scale: 1:10 & 1:1

Ultratone™ Perforated GIB® Plasterboard

Item:	UL13.1224.15/30.W3L1
Perforations:	15mm hole @ 30mm centres
Sheet Size:	2400mm (L) x 1200mm (W)
Border:	67.5mm (L) & 67.5mm (W)
Open Area*:	13.99%

*Includes non perforated border.

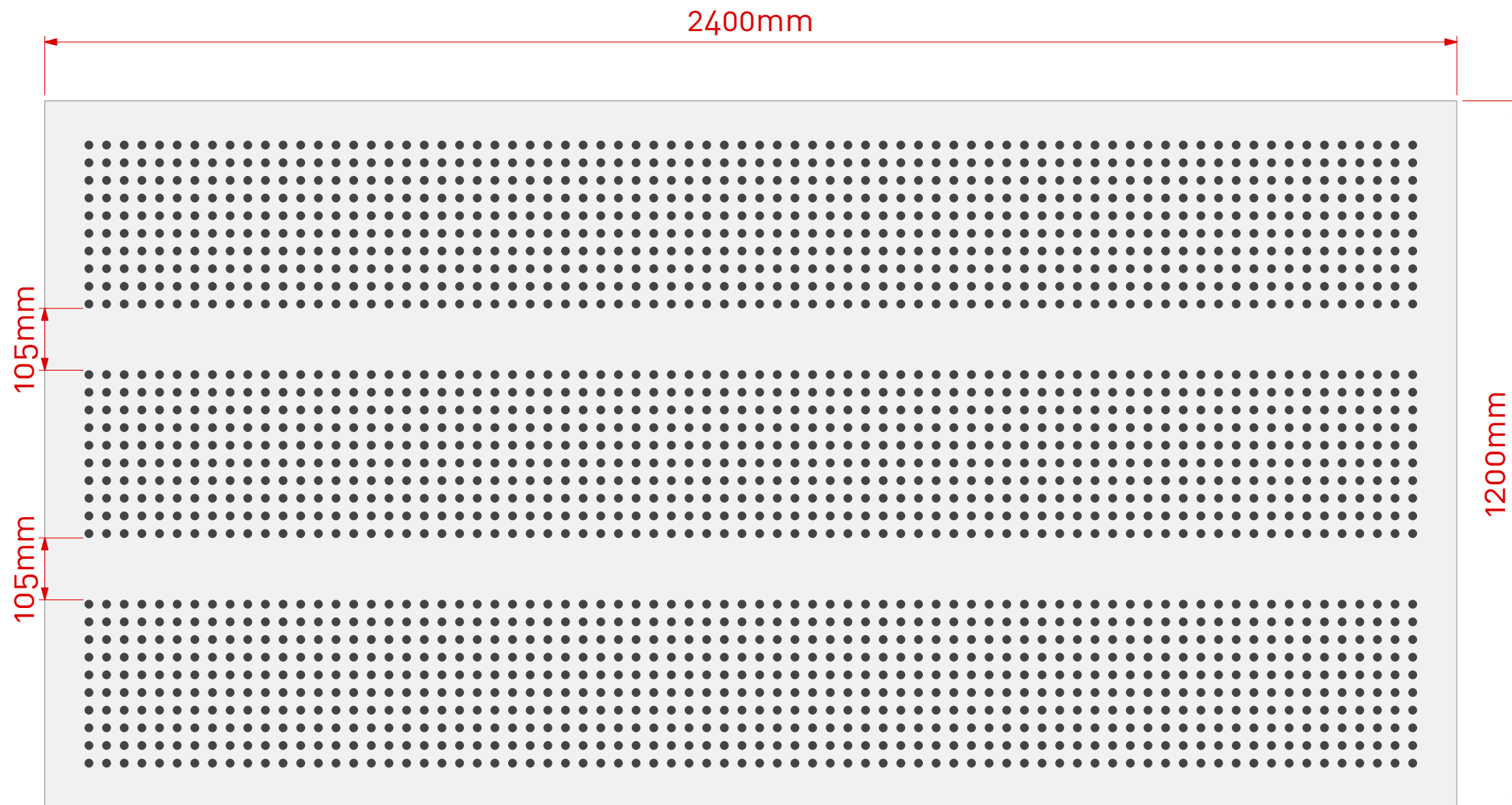

Note: Panel size, border and non perforated areas can be varied to suit project, consult Asona

Scale 1:10 @ A3

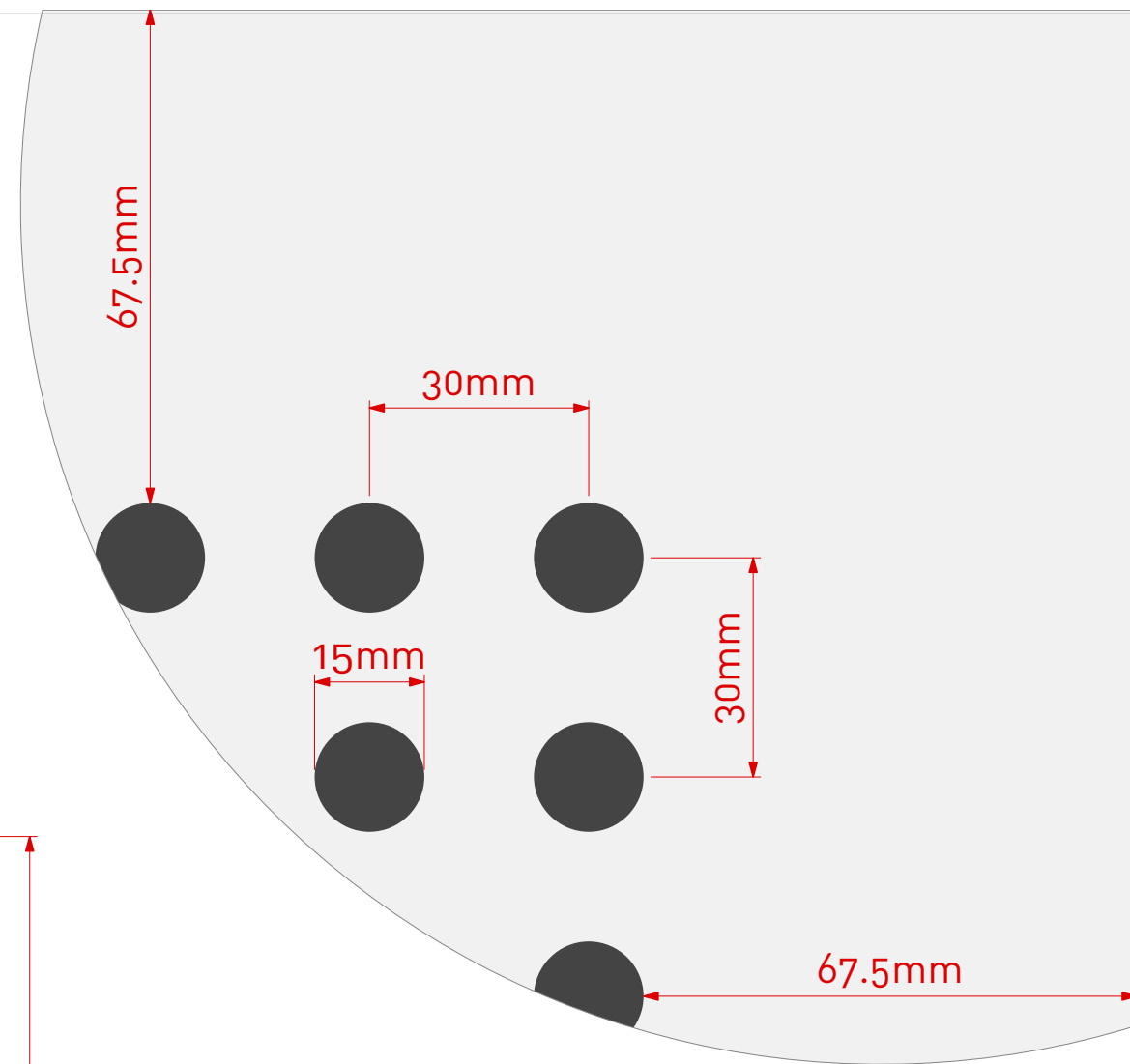

Scale 1:1 @ A3



Cluster Group



www.asona.co.nz

info@asona.co.nz

6 Mahunga Drive, Mangere Bridge
Auckland 2022, New Zealand
Tel: +64 9 525 6575

Ultratone Perforated GIB® Plasterboard

Product: Ultratone GIB®

Customer:

Project Name:

Job Number: TBC

APPROVED

Date: / /

Name:

Sign:

NOTES

View: Face View

Drawing Number: UL13.1224.15/30.W3L1

Drawing Date: 10/10/24

Drawn: SL

Scale: 1:10 & 1:1

Ultratone™ Perforated GIB® Plasterboard

Item:	UL13.1224.12-20/66.W1L1
Perforations:	12/20mm holes @ 33.7mm centres
Sheet Size:	2400mm (L) x 1200mm (W)
Border:	61.05mm (L) & 67.65mm (W)
Open Area*:	16.14%

*Includes non perforated border.

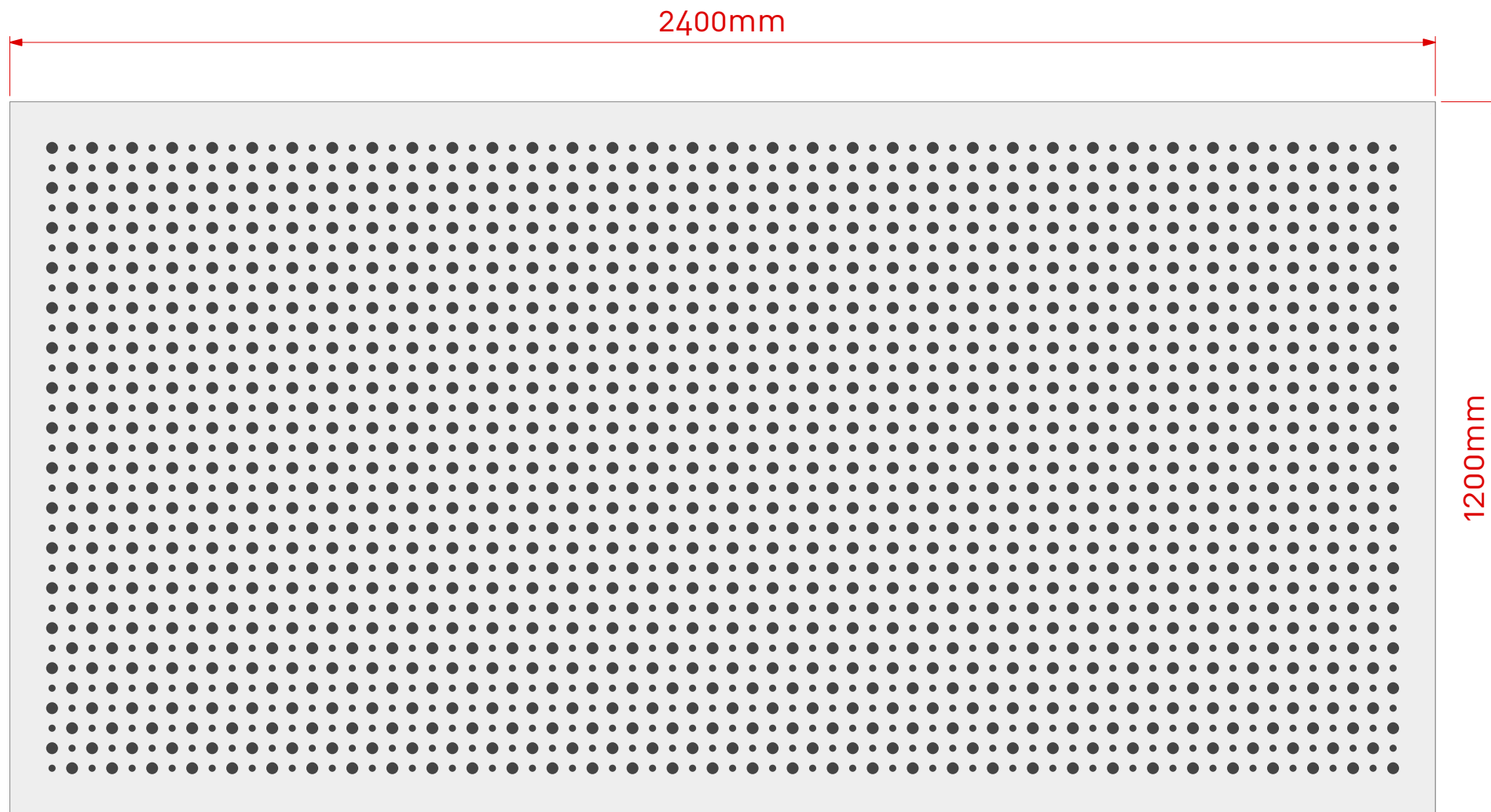

Note: Panel size, border and non perforated areas can be varied to suit project, consult Asona

Scale 1:10 @ A3

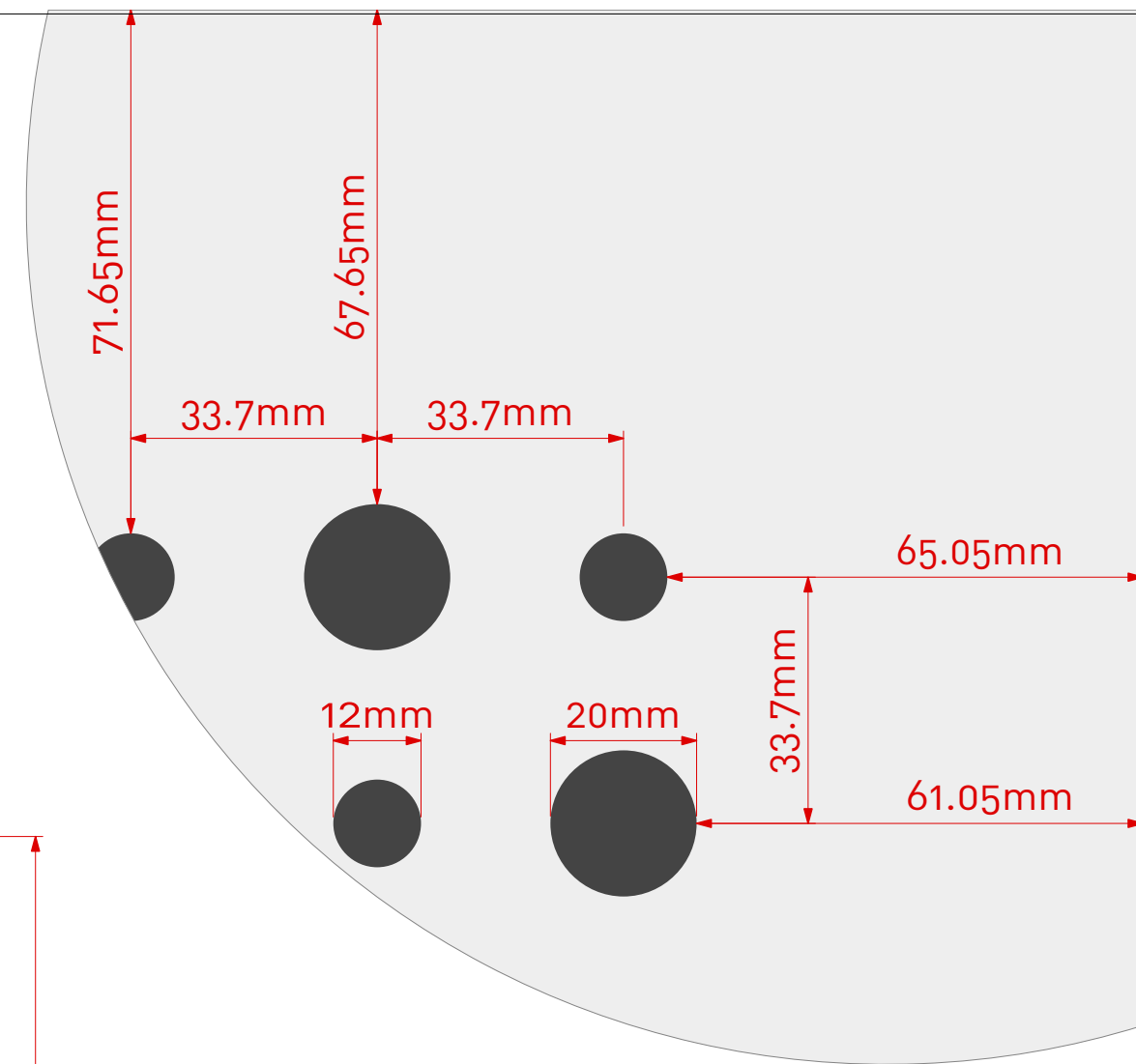

Scale 1:1 @ A3



Cluster Group



www.asona.co.nz

info@asona.co.nz

6 Mahunga Drive, Mangere Bridge
Auckland 2022, New Zealand
Tel: +64 9 525 6575

Ultratone Perforated GIB® Plasterboard

Product:	Ultratone GIB®
Customer:	
Project Name:	
Job Number:	TBC

APPROVED
Date: / /
Name:
Sign:

NOTES

View: Face View

Drawing Number:	UL13.1224.12-20/66.W1L1
Drawing Date:	10/10/24
Drawn:	SL
Scale:	1:10 & 1:1

Ultratone™ Perforated GIB® Plasterboard

Item:	UL13.1224.8-15-20R.W1L1
Perforations:	8/15/20mm holes @ random
Sheet Size:	2400mm (L) x 1200mm (W)
Border:	60mm (L) & 60mm (W)
Open Area*:	6.22%

*Includes non perforated border.

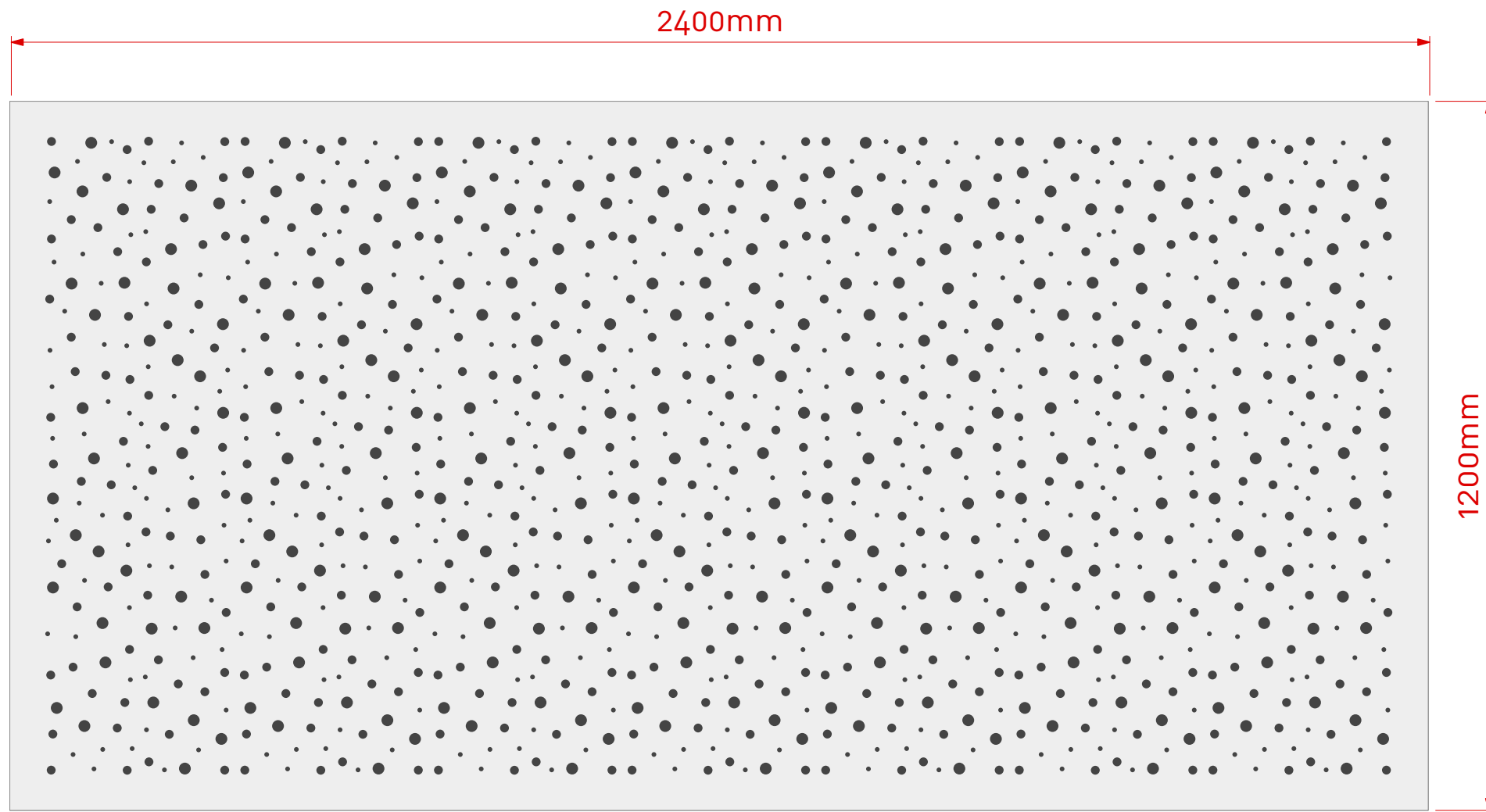

Note: Panel size, border and non perforated areas can be varied to suit project, consult Asona

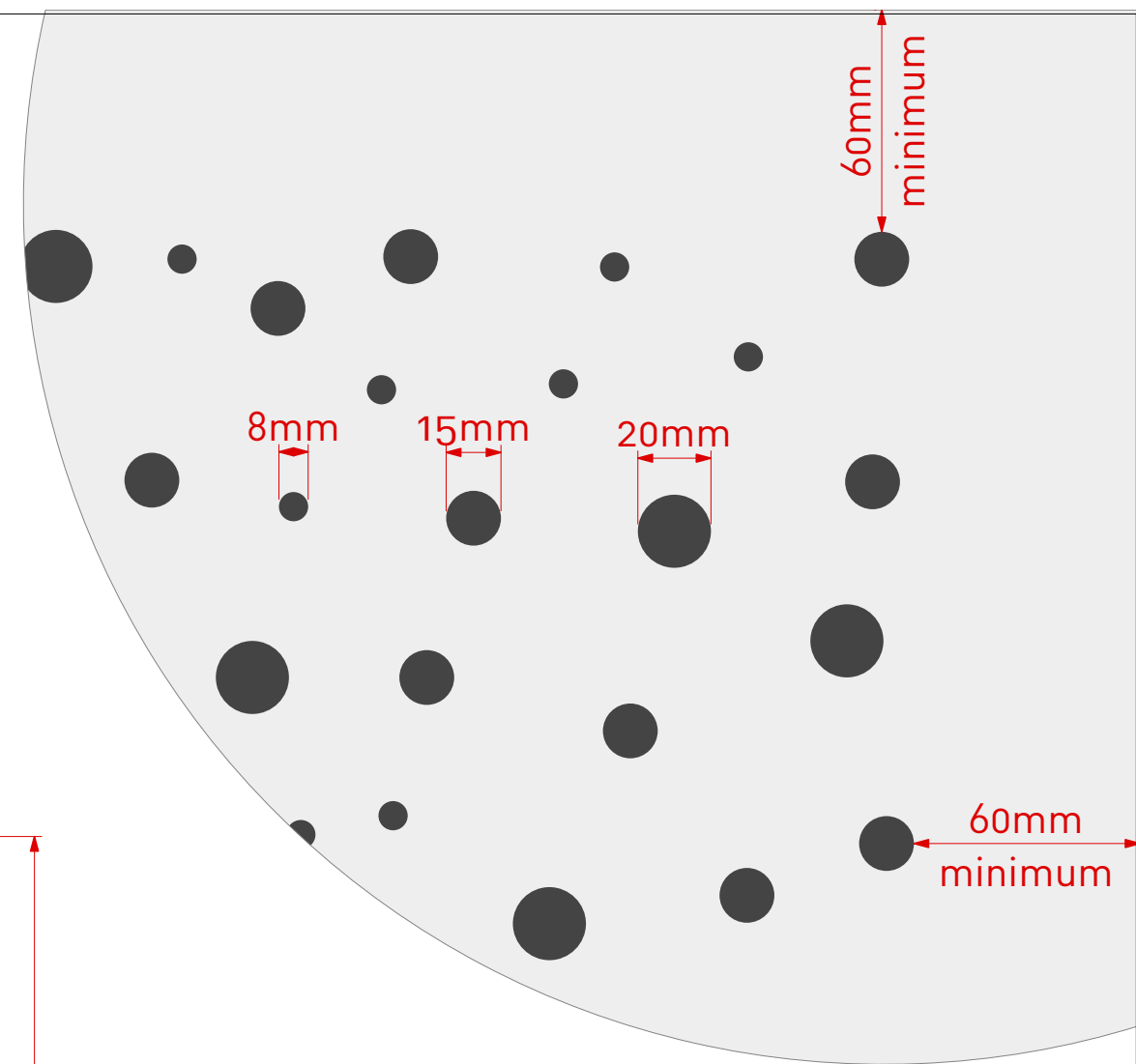

Cluster Group



www.asona.co.nz

info@asona.co.nz

6 Mahunga Drive, Mangere Bridge
Auckland 2022, New Zealand
Tel: +64 9 525 6575

Ultratone Perforated GIB® Plasterboard

Product: Ultratone GIB®

Customer:

Project Name:

Job Number: TBC

APPROVED

Date: / /

Name:

Sign:

NOTES

View: Face View

Drawing Number: UL13.1224.8-15-20R.W1L1

Drawing Date: 10/10/24

Drawn: SL

Scale: 1:10 & 1:2

Ultratone™ Perforated GIB® Plasterboard

Item:	UL13.1224.SQ12/30.W1L1
Perforations:	12mm squares @ 30mm centres
Sheet Size:	2400mm (L) x 1200mm (W)
Border:	69mm (L) & 695mm (W)
Open Area*:	13.68%

*Includes non perforated border.

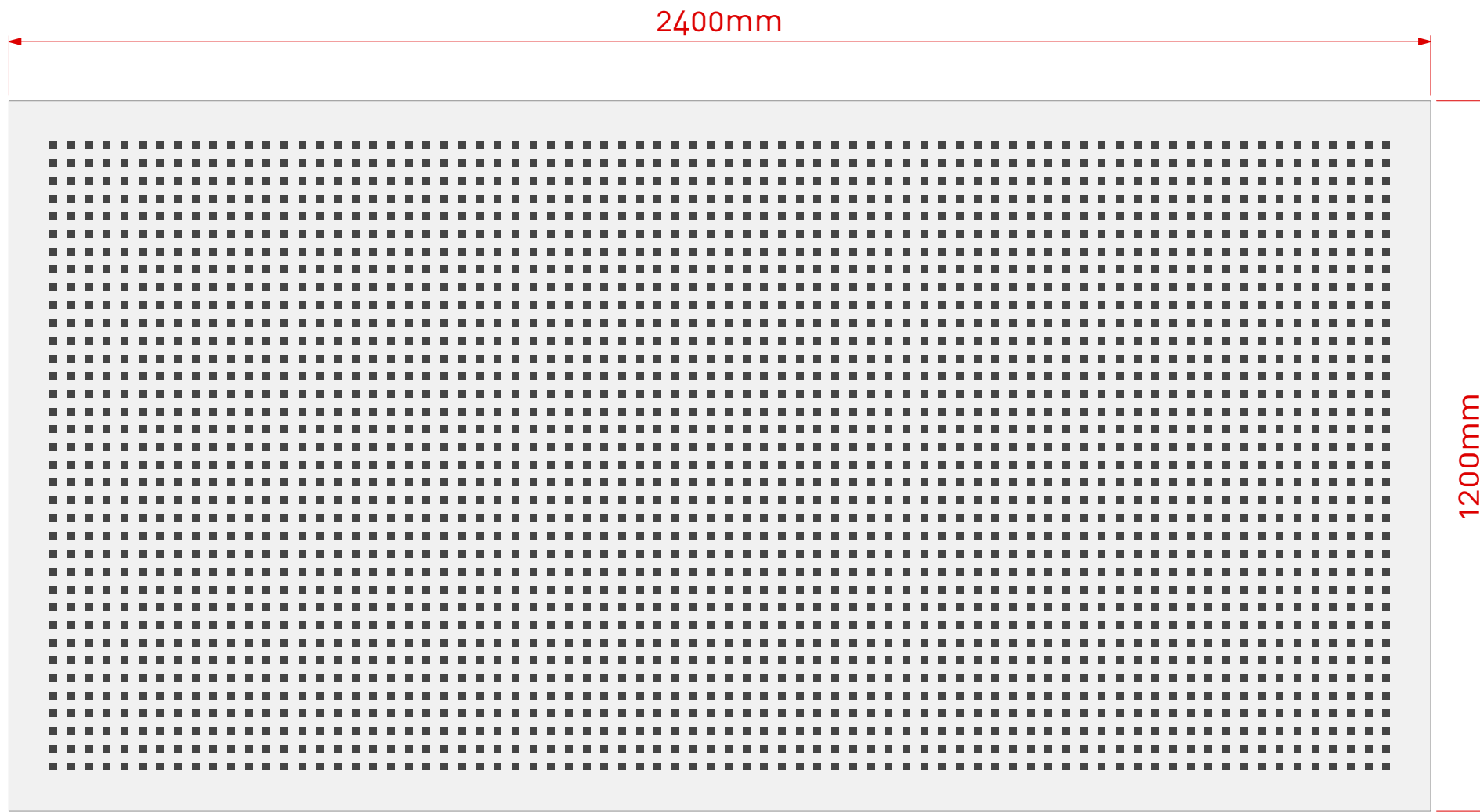

Note: Panel size, border and non perforated areas can be varied to suit project, consult Asona

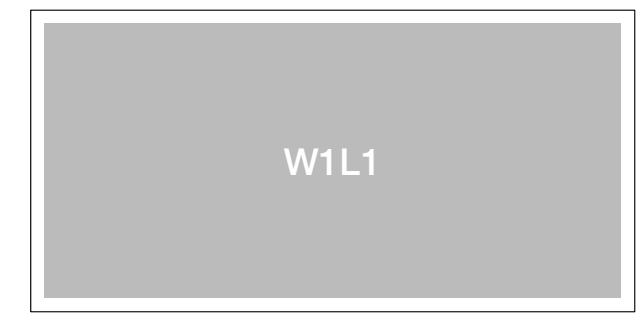
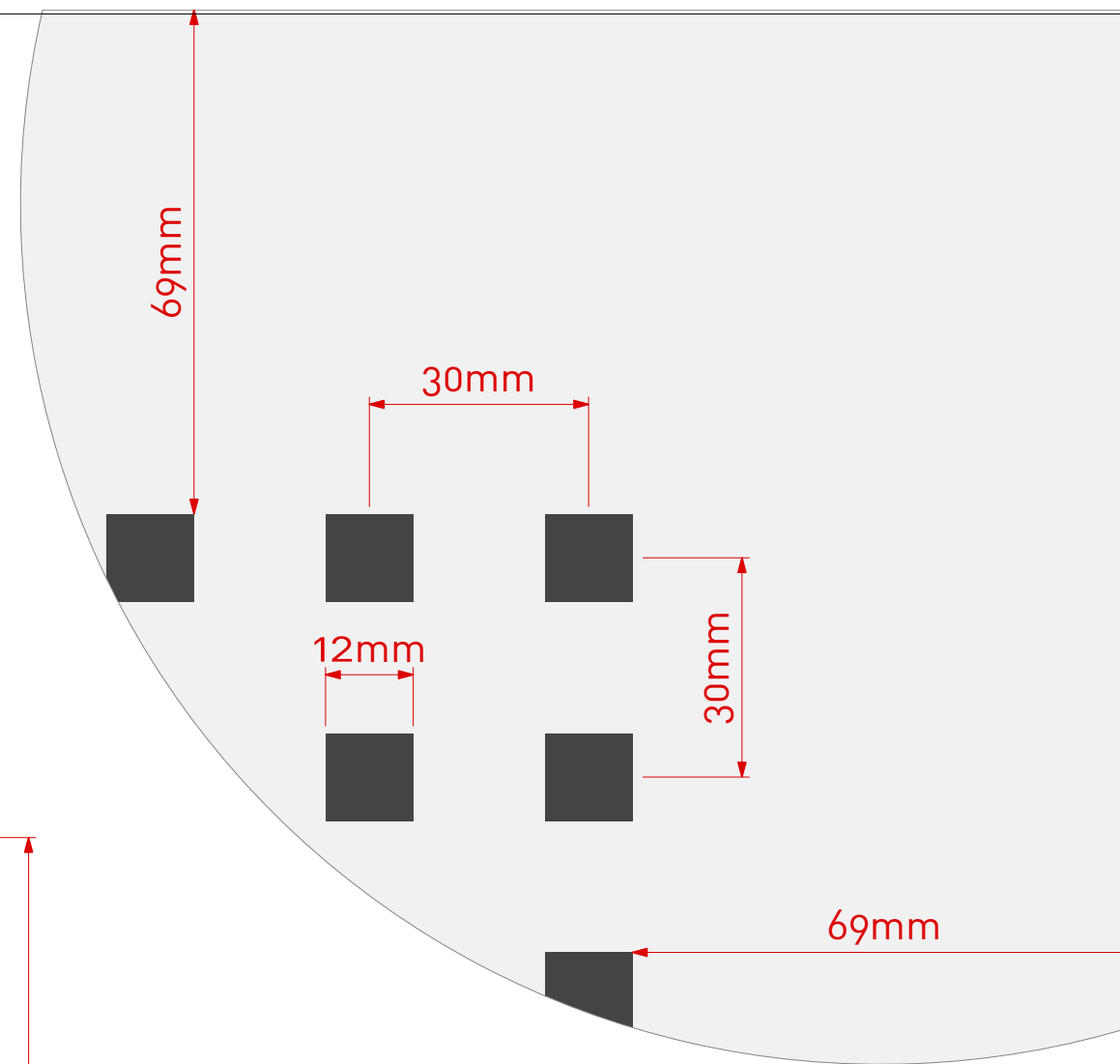

Cluster Group



www.asona.co.nz

info@asona.co.nz

6 Mahunga Drive, Mangere Bridge
Auckland 2022, New Zealand
Tel: +64 9 525 6575

Ultratone Perforated GIB® Plasterboard

Product: Ultratone GIB®

Customer:

Project Name:

Job Number: TBC

APPROVED

Date: / /

Name:

Sign:

NOTES

View: Face View

Drawing Number: UL13.1224.SQ12/30.W1L1

Drawing Date: 10/10/24

Drawn: SL

Scale: 1:10 & 1:1

Ultratone™ Perforated GIB® Plasterboard

Item:	UL13.1224.SQ12/30.W1L2
Perforations:	12mm squares @ 30mm centres
Sheet Size:	2400mm (L) x 1200mm (W)
Border:	69mm (L) & 69mm (W)
Open Area*:	12.96%

*Includes non perforated border.

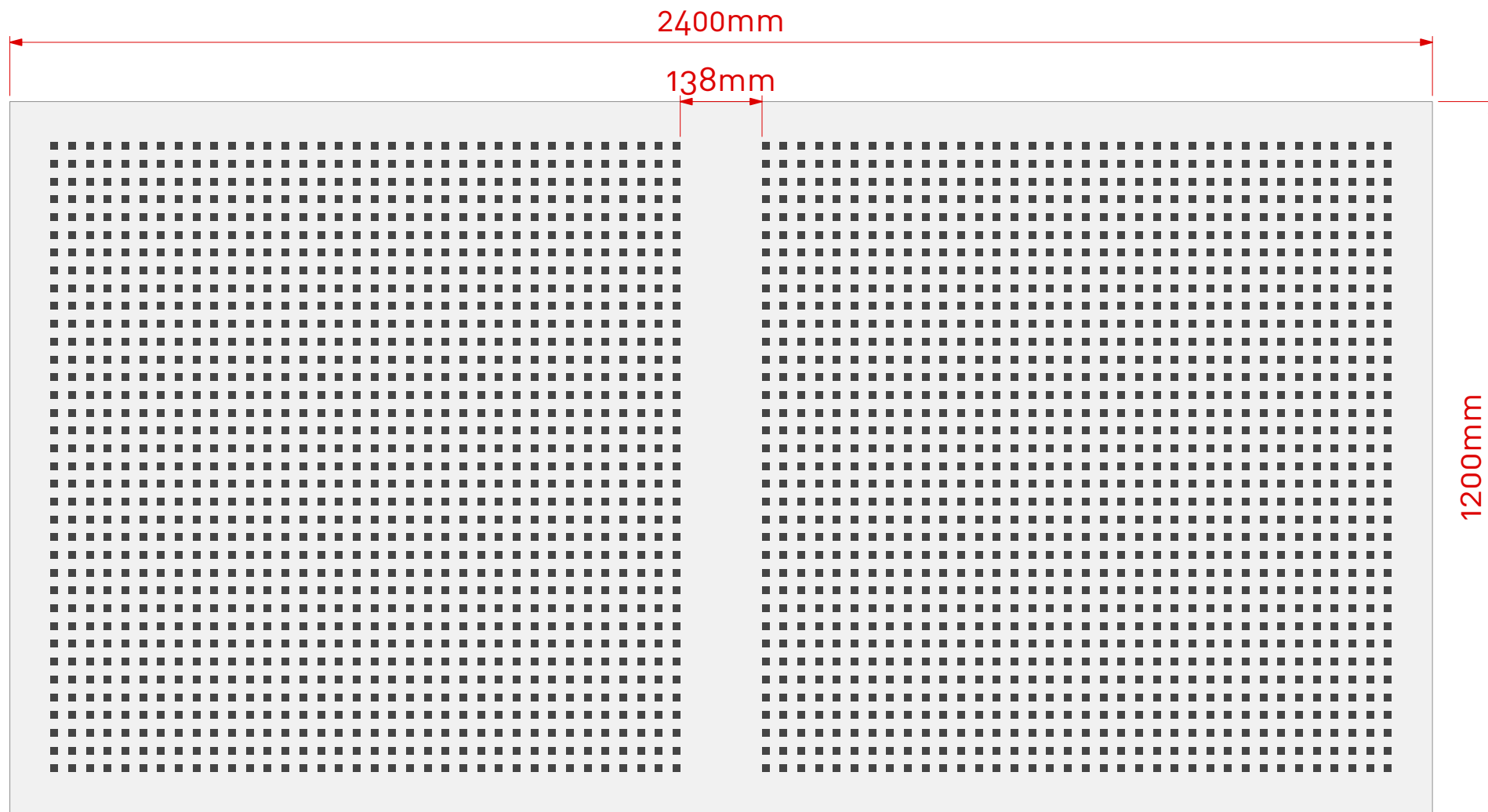

Note: Panel size, border and non perforated areas can be varied to suit project, consult Asona

Scale 1:10 @ A3

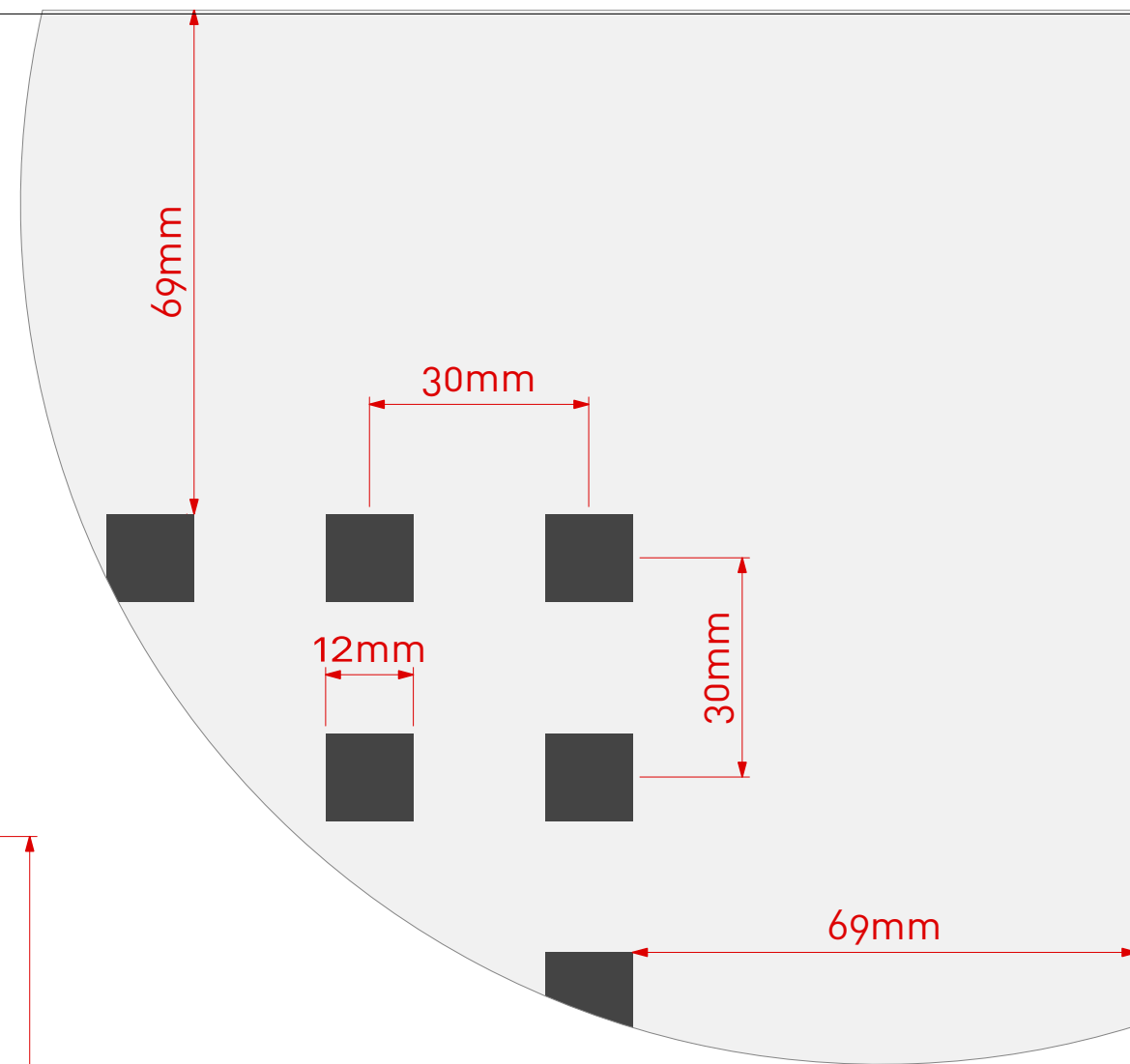

Scale 1:1 @ A3



Cluster Group

asona

www.asona.co.nz

info@asona.co.nz

6 Mahunga Drive, Mangere Bridge
Auckland 2022, New Zealand
Tel: +64 9 525 6575

Ultratone Perforated GIB® Plasterboard

Product: Ultratone GIB®

Customer:

Project Name:

Job Number: TBC

APPROVED

Date: / /

Name:

Sign:

NOTES

View: Face View

Drawing Number: UL13.1224.SQ12/30.W1L2

Drawing Date: 10/10/24

Drawn: SL

Scale: 1:10 & 1:1

Ultratone™ Perforated GIB® Plasterboard

Item:	UL13.1224.SQ12/30.W2L1
Perforations:	12mm squares @ 30mm centres
Sheet Size:	2400mm (L) x 1200mm (W)
Border:	69mm (L) & 69mm (W)
Open Area*:	12.16%

*Includes non perforated border.

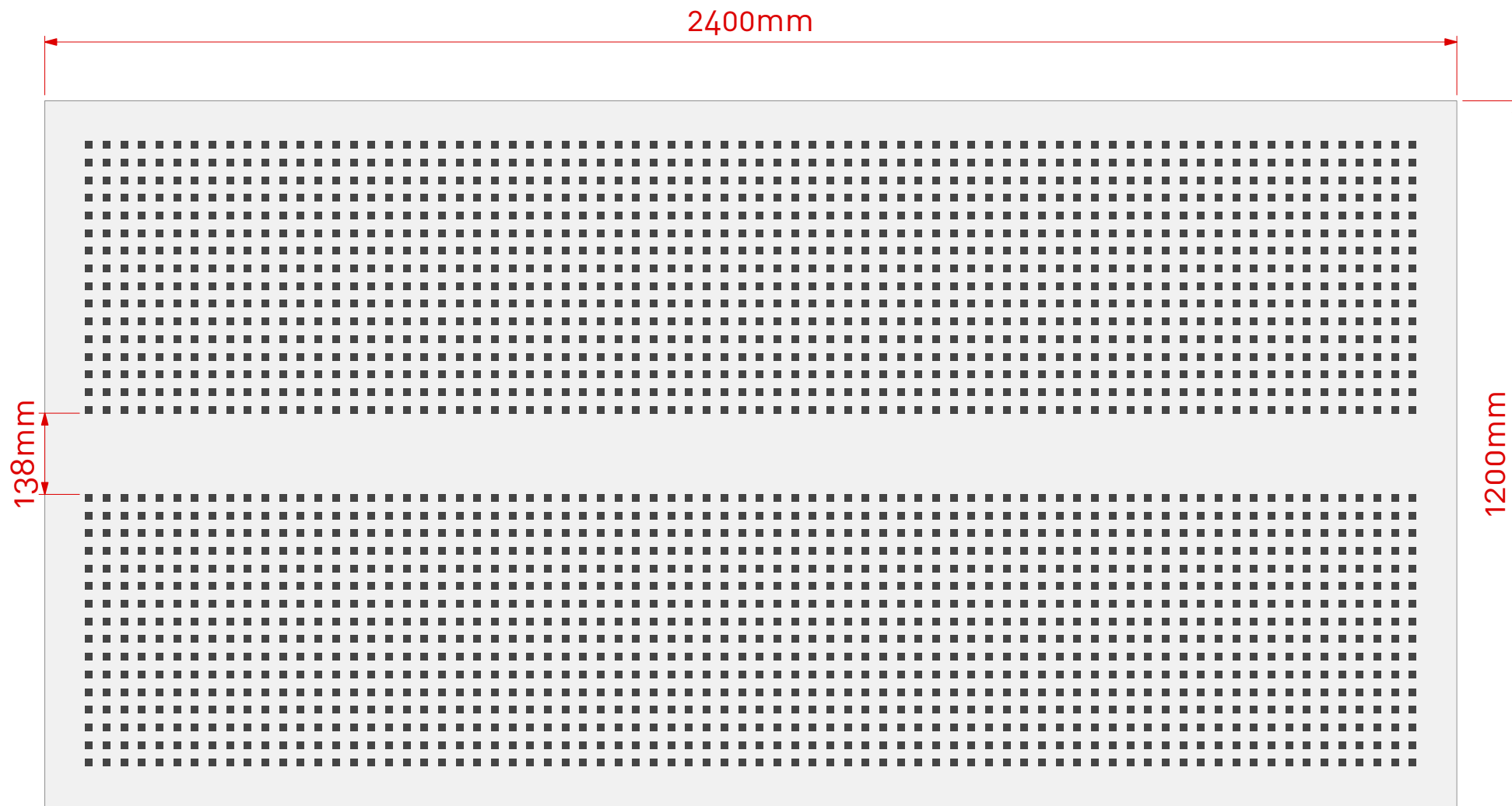

Note: Panel size, border and non perforated areas can be varied to suit project, consult Asona

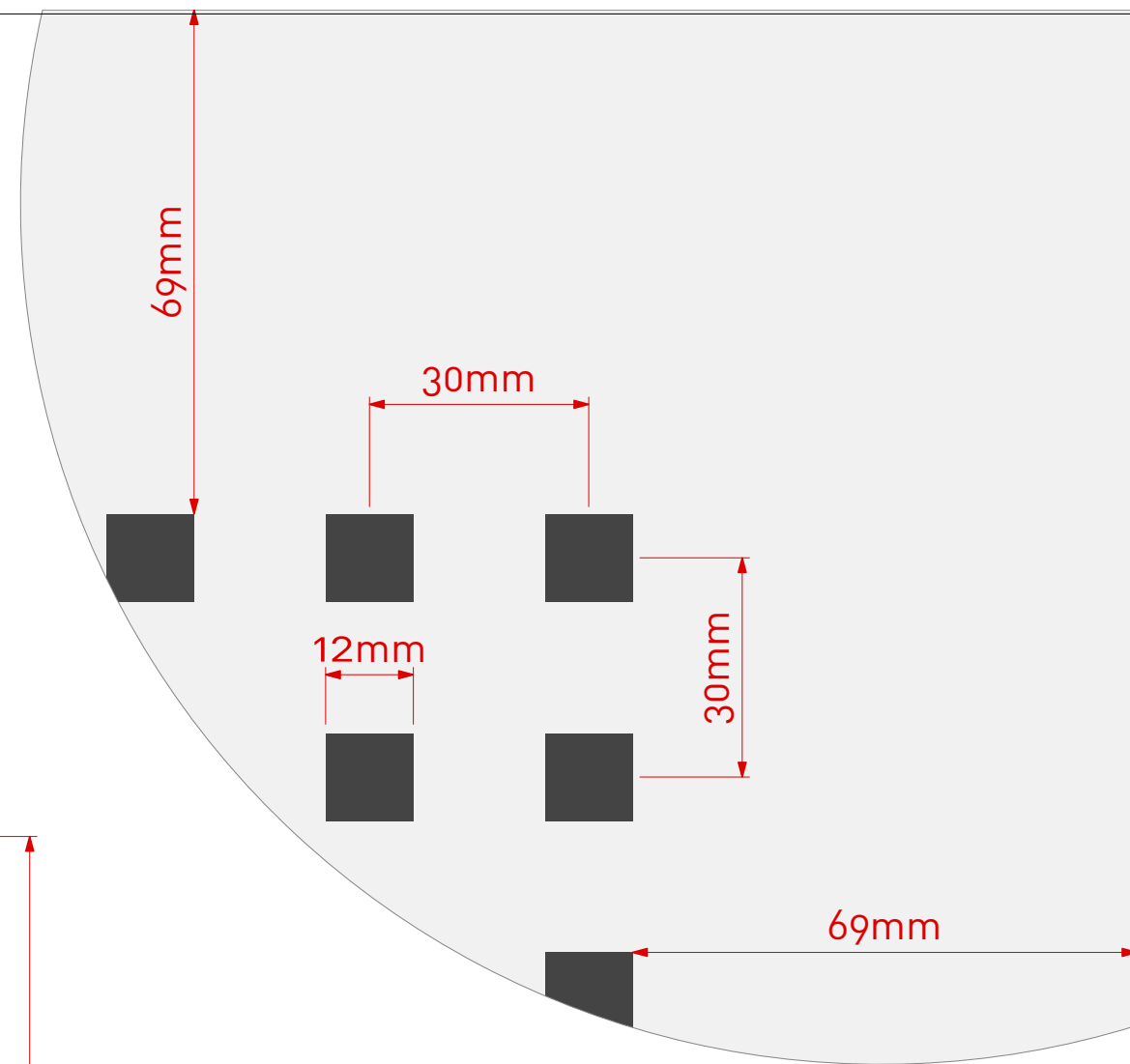

Cluster Group



www.asona.co.nz

info@asona.co.nz

6 Mahunga Drive, Mangere Bridge
Auckland 2022, New Zealand
Tel: +64 9 525 6575

Ultratone Perforated GIB® Plasterboard

Product: Ultratone GIB®

Customer:

Project Name:

Job Number: TBC

APPROVED

Date: / /

Name:

Sign:

NOTES

View: Face View

Drawing Number: UL13.1224.SQ12/30.W2L1

Drawing Date: 10/10/24

Drawn: SL

Scale: 1:10 & 1:1

Ultratone™ Perforated GIB® Plasterboard

Item:	UL13.1224.SQ12/30.W2L2
Perforations:	12mm squares @ 30mm centres
Sheet Size:	2400mm (L) x 1200mm (W)
Border:	69mm (L) & 69mm (W)
Open Area*:	11.52%

*Includes non perforated border.

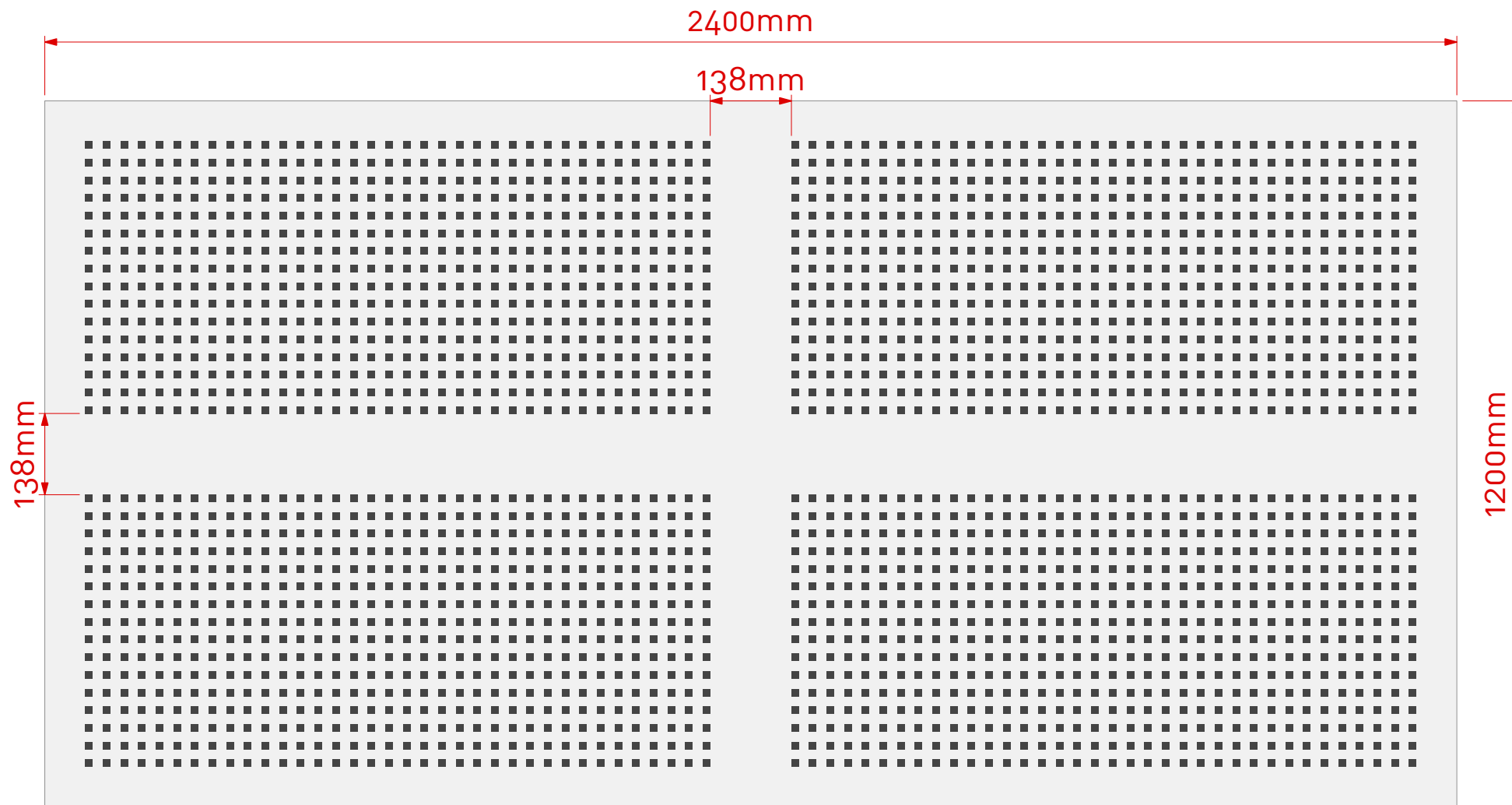

Note: Panel size, border and non perforated areas can be varied to suit project, consult Asona

Scale 1:10 @ A3

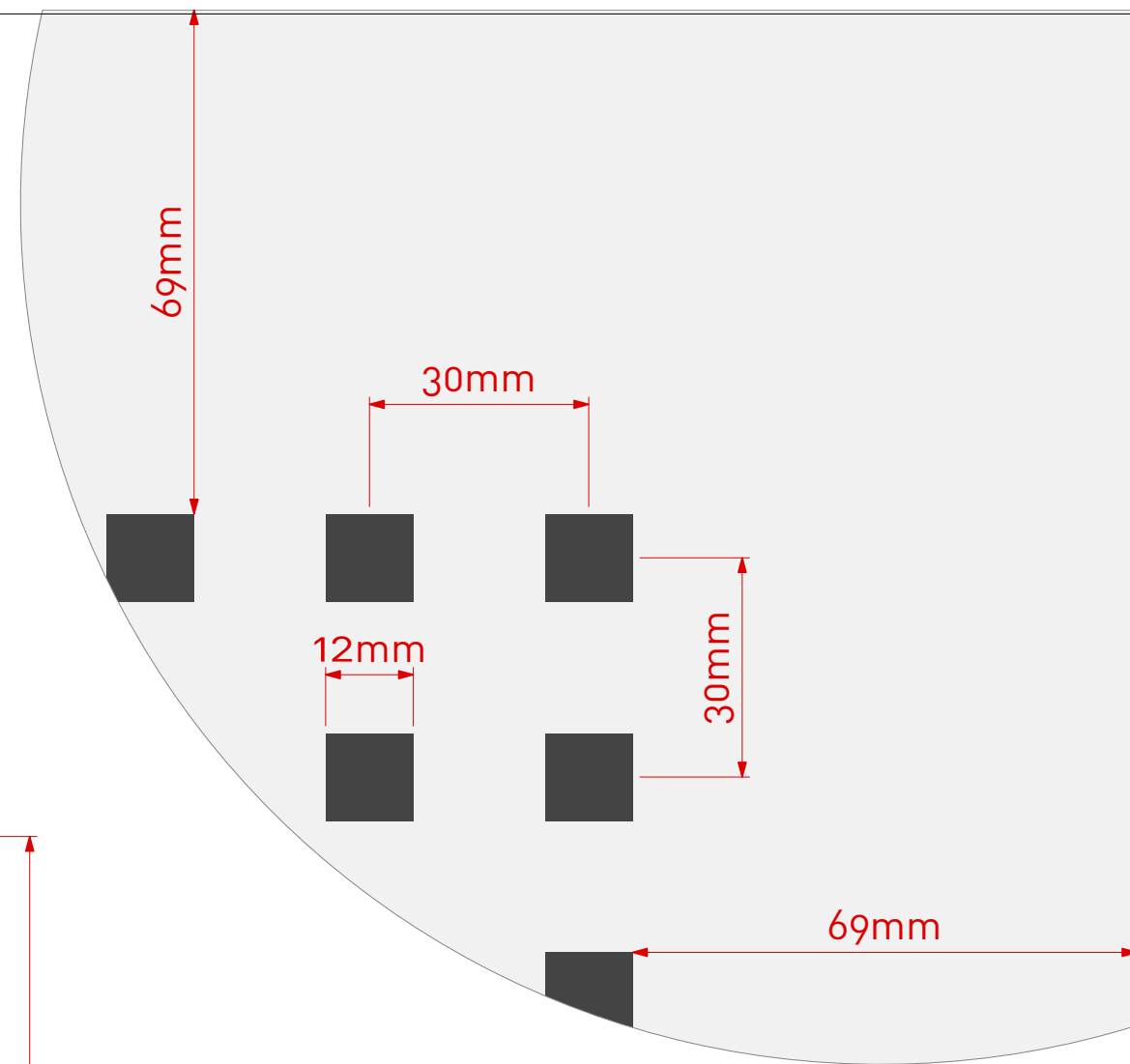

Scale 1:1 @ A3

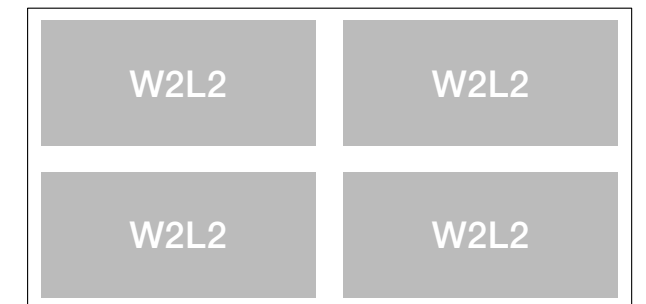

Cluster Group



www.asona.co.nz

info@asona.co.nz

6 Mahunga Drive, Mangere Bridge
Auckland 2022, New Zealand
Tel: +64 9 525 6575

Ultratone Perforated GIB® Plasterboard

Product: Ultratone GIB®

Customer:

Project Name:

Job Number: TBC

APPROVED

Date: / /

Name:

Sign:

NOTES

View: Face View

Drawing Number: UL13.1224.SQ12/30.W2L2

Drawing Date: 10/10/24

Drawn: SL

Scale: 1:10 & 1:1

Ultratone™ Perforated GIB® Plasterboard

Item:	UL13.1224.SQ12/30.W2L4
Perforations:	12mm squares @ 30mm centres
Sheet Size:	2400mm (L) x 1200mm (W)
Border:	69mm (L) & 69mm (W)
Open Area*:	8.68%

*Includes non perforated border.

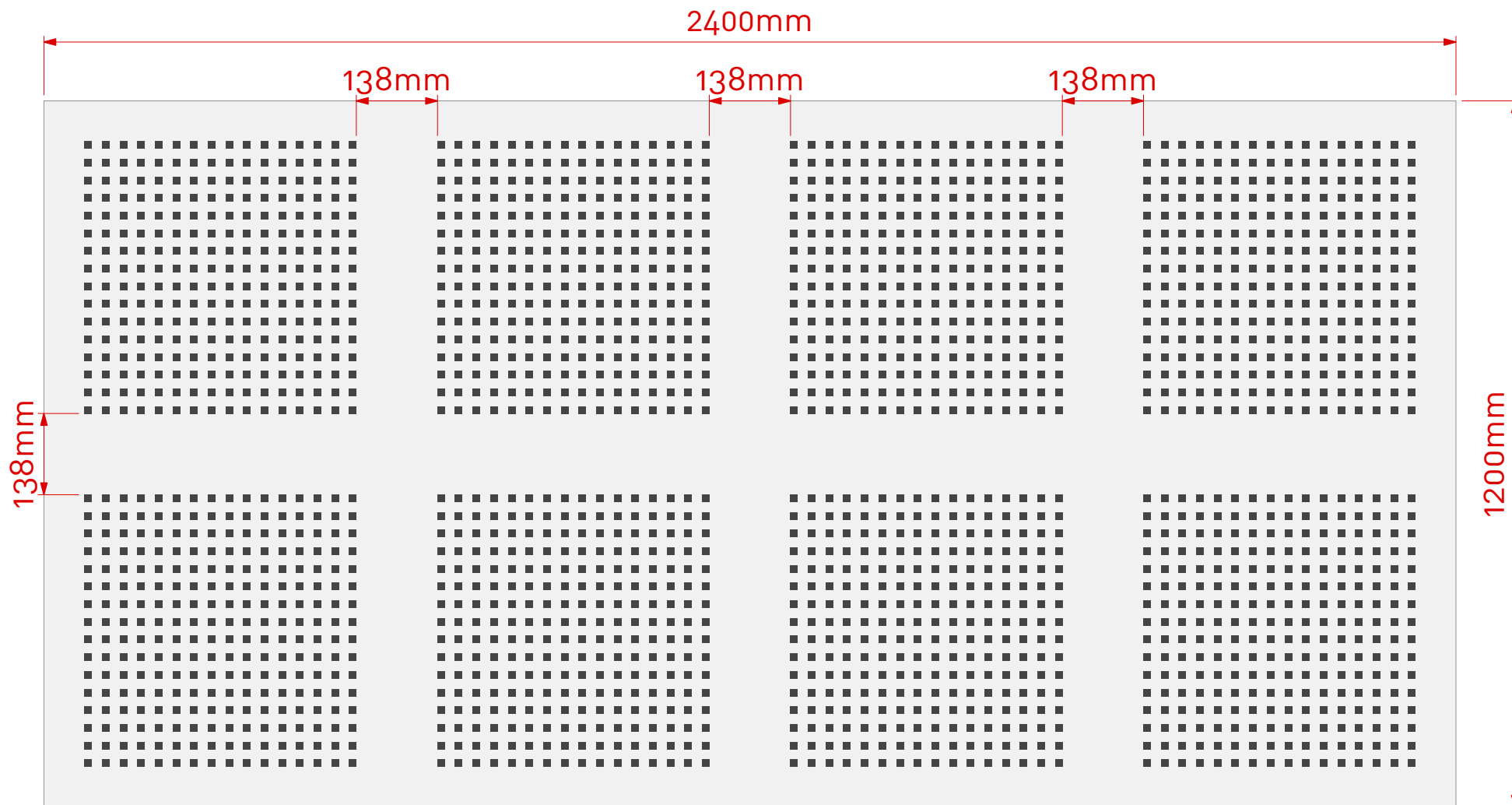

Note: Panel size, border and non perforated areas can be varied to suit project, consult Asona

Scale 1:10 @ A3

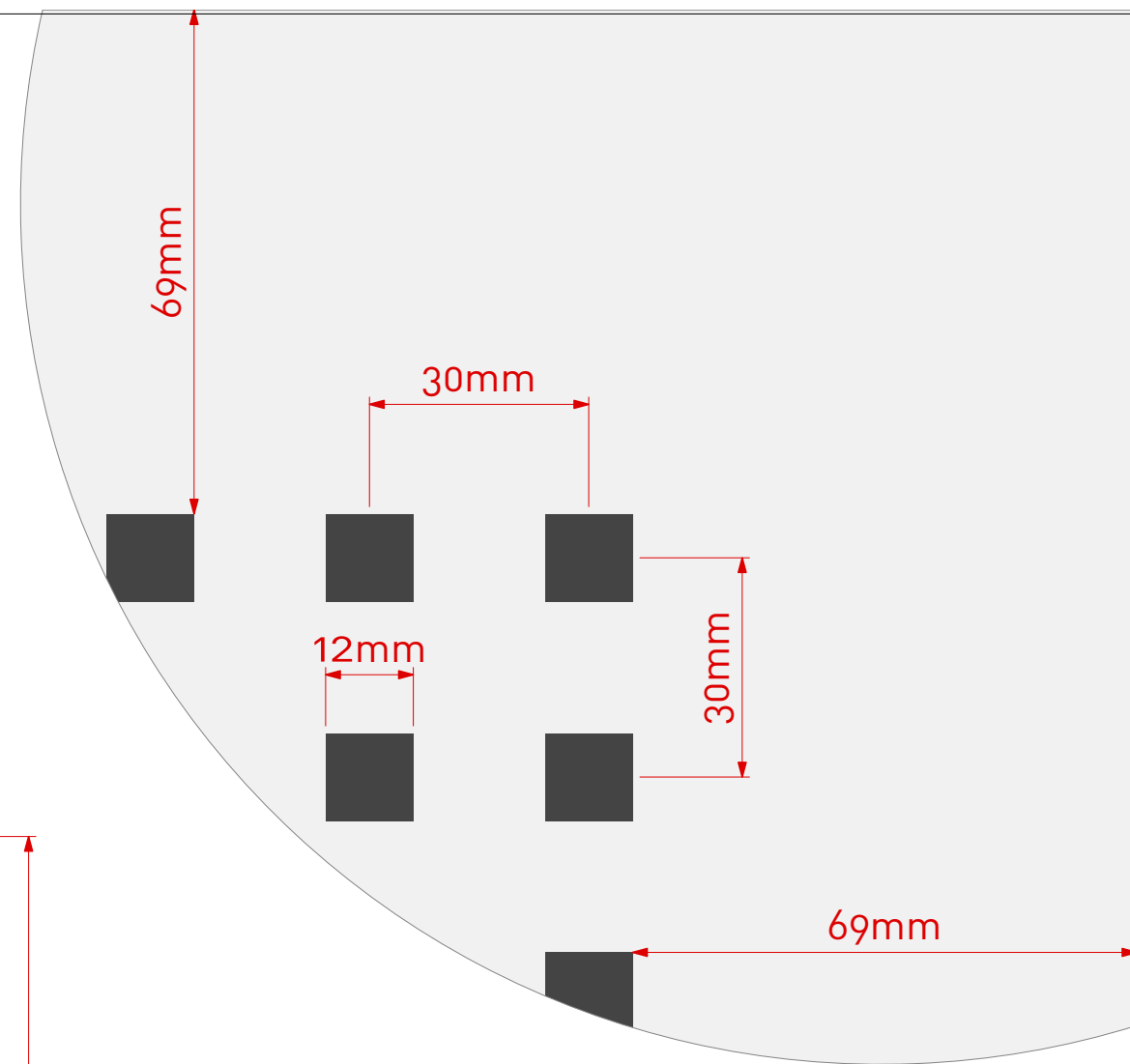

Scale 1:1 @ A3



Cluster Group



www.asona.co.nz

info@asona.co.nz

6 Mahunga Drive, Mangere Bridge
Auckland 2022, New Zealand
Tel: +64 9 525 6575

Ultratone Perforated GIB® Plasterboard

Product:	Ultratone GIB®
Customer:	
Project Name:	
Job Number:	TBC

APPROVED
Date: / /
Name:
Sign:

NOTES

View: Face View

Drawing Number:	UL13.1224.SQ12/30.W2L4
Drawing Date:	10/10/24
Drawn:	SL
Scale:	1:10 & 1:1

Ultratone™ Perforated GIB® Plasterboard

Item:	UL13.1224.SQ12/30.W3L1
Perforations:	12mm squares @ 30mm centres
Sheet Size:	2400mm (L) x 1200mm (W)
Border:	69mm (L) & 69mm (W)
Open Area*:	11.40%

*Includes non perforated border.

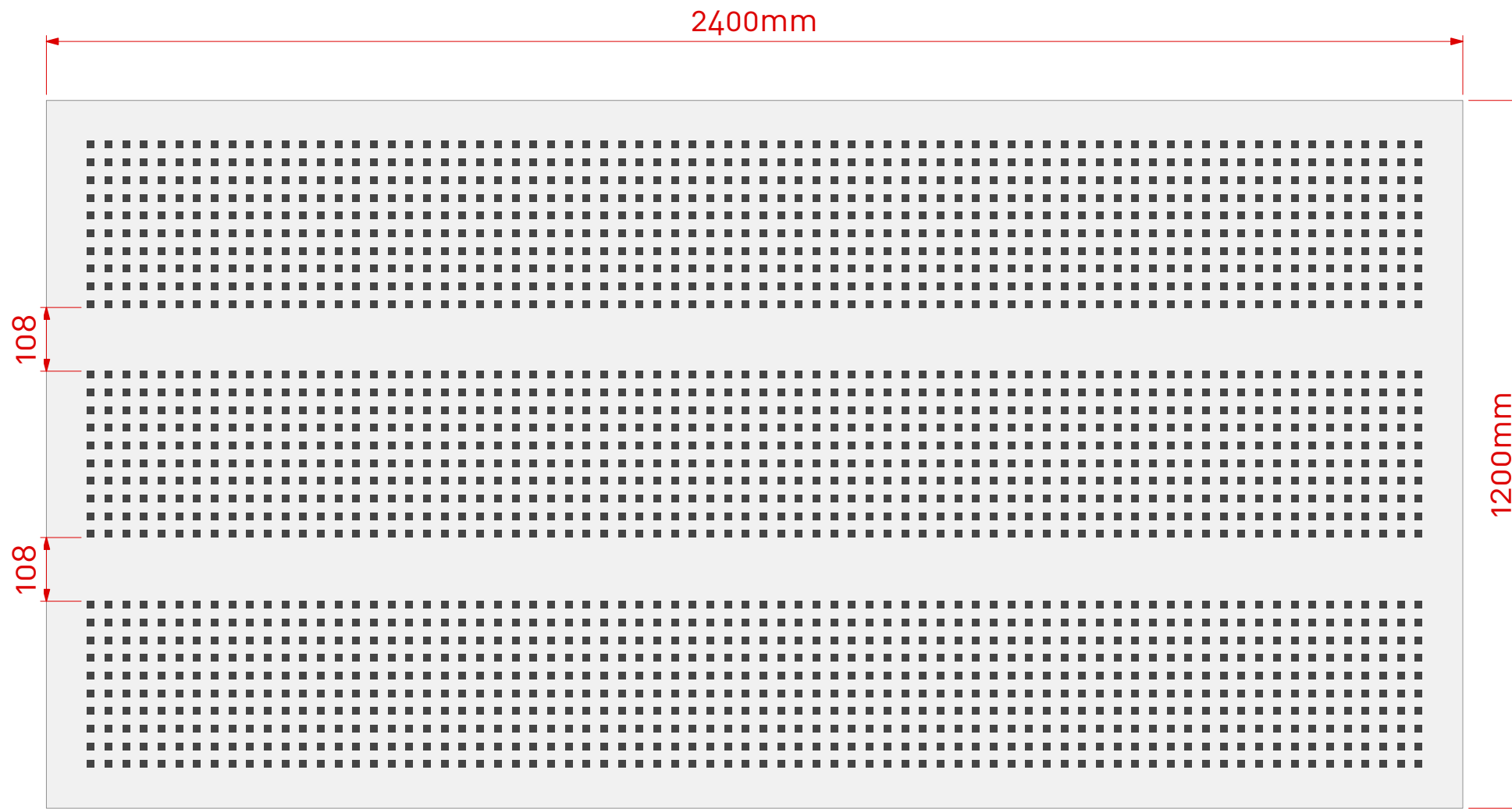

Note: Panel size, border and non perforated areas can be varied to suit project, consult Asona

Scale 1:10 @ A3

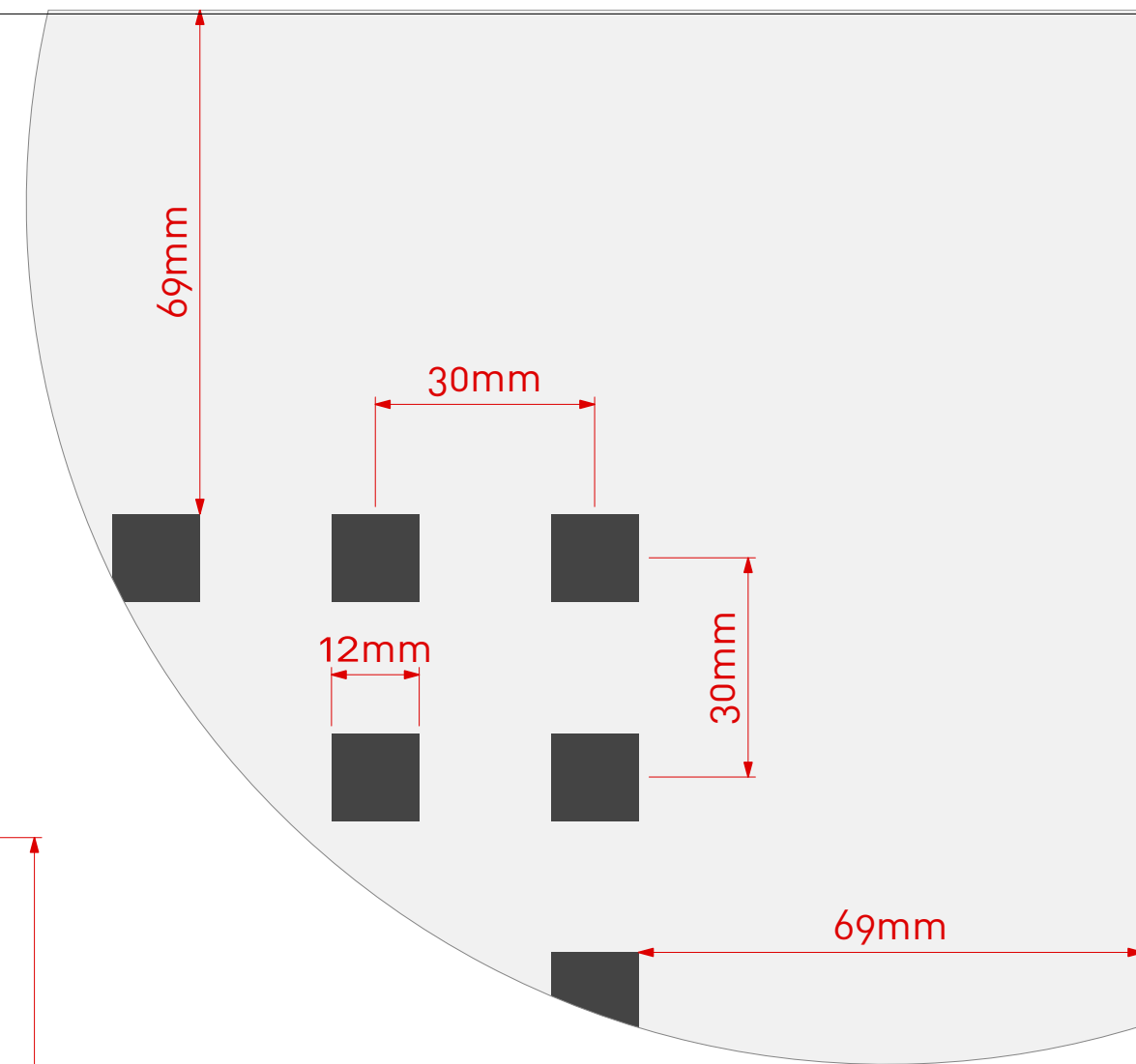

Scale 1:1 @ A3

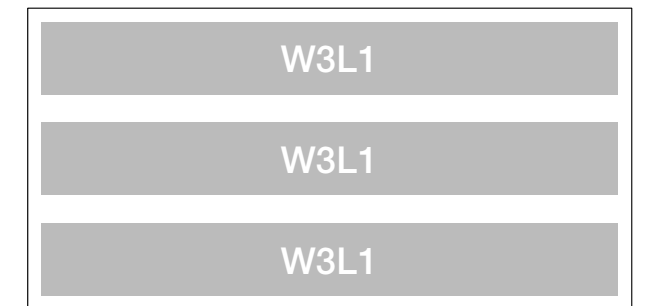

Cluster Group



www.asona.co.nz

info@asona.co.nz

6 Mahunga Drive, Mangere Bridge
Auckland 2022, New Zealand
Tel: +64 9 525 6575

Ultratone Perforated GIB® Plasterboard

Product: Ultratone GIB®

Customer:

Project Name:

Job Number: TBC

APPROVED

Date: / /

Name:

Sign:

NOTES

View: Face View

Drawing Number: UL13.1224.SQ12/30.W3L1

Drawing Date: 10/10/24

Drawn: SL

Scale: 1:10 & 1:1